

FEEL THE BREEZE

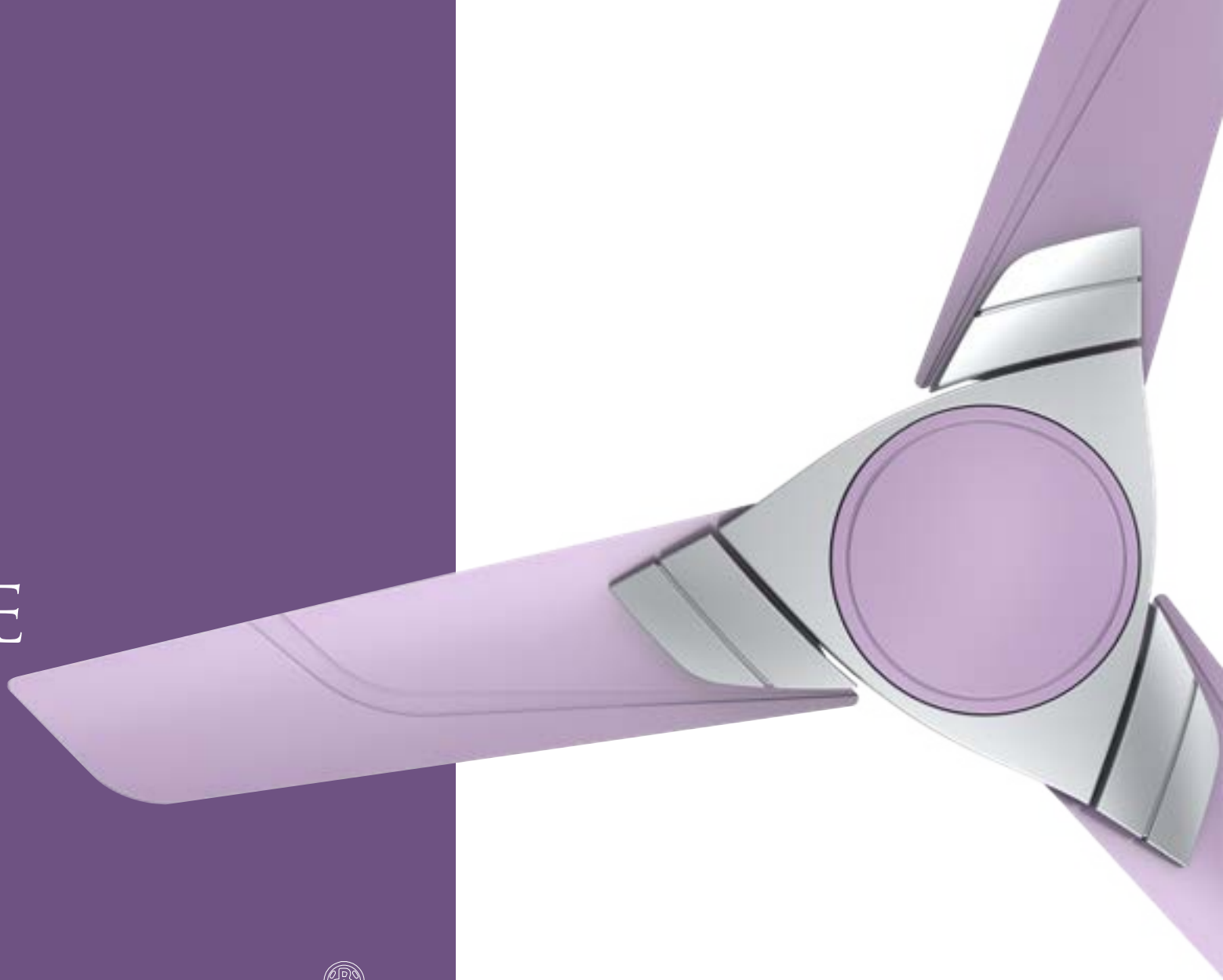

CEILING FANS | TABLE FANS | WALL FANS | EXHAUST FANS | PEDESTAL FANS

CONTENTS

SUPER PREMIUM CEILING FANS

06	Superia Lite SP01
08	Superia Lite SP02
10	Superia Lite SP03
12	Superia Lite SP04
14	Superia Lite SP05
16	Superia Lite SP06
18	Superia Lite SP07

PUROCOAT FANS

28	Aereo
30	Euphoria-EP01
32	Euphoria-EP02
34	Tryst
36	Revere
38	Aspire
40	Eleganz Purocoat
42	Eleganz D-ziner Purocoat
44	Eleganz Floral Purocoat

PREMIUM CEILING FANS

48	Eliana
50	Metallica
52	Vital Platinum
54	Crystal
56	India Glory
58	Stunner
60	Elanza
62	Brio

64	Vital
66	Regalia

ENERGY SAVER CEILING FANS

70	Elanza Plus
72	Zoomer Plus
74	Affeciante Neo
76	Arne
78	Power Saver 35 BLDC
80	Affeciente BLDC 32

ECONOMY CEILING FANS

84	Eterna
86	Maven
88	Charisma
90	Zoomer
92	Amaze HS
94	Amaze DLX
96	Glory
98	Juno
100	Juno DLX
102	Zoomer DLX
104	Sylphy
106	Sylphy DLX
108	Annular
110	Annular DLX
112	Viva
114	Viva DLX
116	Revivo

TABLE FANS

122	Aery
124	Thunderstorm
126	Unicorn
128	Eliana
130	Amaze
132	Elanza PT01

PEDESTAL FANS

136	Aery
138	Thunderstorm
140	Unicorn
142	Eliana
144	Amaze
146	Aspire
148	Elanza PP01
150	Elanza Mini

WALL FANS

154	Aery
156	Thunderstorm
158	Unicorn
160	Eliana
162	Aspire
164	Amaze
166	Elanza PW01

PERSONAL & CABIN FANS

170	Cutie
172	Peppy Personal Fan

174	Fantasy Cabin Fan
-----	--------------------------

FARRATA FANS

178	Maarut Oscillating
180	Sunami Farrata
182	Sunami MK III
184	Toofan Farrata
186	Pawan Farrata

AIR CIRCULATOR FANS

190	Air Circulator Superb Wall Fan
192	Air Circulator Superb Pedestal Fan

EXHAUST FANS

196	Freshner Ventilation
198	Freshner AXL
200	Fresh On DBB
202	Freshner ES Metal
204	Airo Fresh
206	Freshobreeze
208	Revivo
210	Superb Heavy Duty
212	Whoosh
214	Viva





SETTING GLOBAL BENCHMARKS IN MANUFACTURING

Ever since its inception in 1964, Polycab has been relentlessly innovating to make lives easier and safer. Driven by an unwavering commitment to quality and delighting consumers, Polycab has evolved from being India's largest wire and cable manufacturer to becoming one of the country's leading end-to-end electrical solutions brands.

Polycab fans are meticulously designed for aspiring consumers and come in an extensive portfolio that includes ceiling fans, table fans, wall mounted fans, fresh air exhaust fans and Farrata. Polycab fans are manufactured in one of India's largest fan factories in Roorkee, Uttarakhand with every process taking place under one roof. Check out the meticulous manufacturing processes listed below which ensure that our customers continue to get products of the highest quality, for years to come.



Automated Copper Winding

The copper winding process is entirely automated and guarantees perfection. Each heavy duty winding uses 99.999% pure copper; thus making it the best in the industry.



Automatic Robotic Paint Shop (imported from Switzerland)

The robotic paint shop, sourced from ITW GEMA, Switzerland coats the various fan parts in a uniform, precise manner. A wide choice of colours followed by a high grade laminated cover to protect the surface complete the in-house painting process.



Perfect dimensions with CNC Machine

The fan's blades along with top and bottom cover are built using high quality aluminium on a dedicated assembly line. CNC machines are used to ensure perfect dimensions. The precise optimum angle of the fan blades creates higher air velocity and distributes air evenly.



In-house Automatic Air-Delivery Testing Lab

Each and every finished product is tested in a specifically designed, in-house Automatic Air-Delivery Testing Lab for air delivery and distribution capacity. Polycab fan's superior air delivery between 225 CMM to 260 CMM will rejuvenate every person in the room with a gust of refreshing breeze.



Computer Controlled 7 Tank Anti-Rust Process

Every body part of the fan goes through a computer controlled 7 Tank Anti-Rust process, which includes degreasing, cleaning, moisture removal and drying. This process enhances the life of the paint coat while giving it a durable and glossy finish.

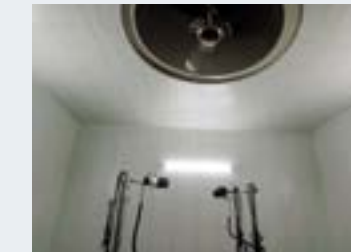

Little wonder that Polycab fans are the perfect choice boasting the best in conventional and contemporary comforts.

KEY FEATURES



Nanova Technology is an advanced coating on the fan blades that ensures protection from dust, rust and harmful bacteria and ensures longer durability of the fan.



It provides a superior finish and long lasting protection to fans.



Abbreviation for Maximum Performance Minimum Voltage. It's a high-performing electric motor that operates at maximum efficiency yet consumes minimum voltage.



Well-defined controls have been put in place to standardize production and quality inspection. Trained personnel conduct regular audits of every material and process from entry to exit stage, ensuring consistent product quality every time.



A high speed ceiling fan is a fan that delivers excellent air circulation throughout the room, owing to its high-performance motor.



A tried and tested process that eliminates material impurities and defects from a painted surface.



The large and wide fan blades ensure maximum air delivery and wide air throw to cool every corner of the room.



Polycab ceiling fans come in a variety of finishes and colors. You can select a color which suits your application and matches your room perfectly. Listed here are the various finishes to choose from:

- Pearl
- Metallic
- Electroplated
- Lustre
- Antique Copper



Polycab fans use double ball bearing that supports the motor and fan shaft at two locations. Such fans have reduced friction and perform consistently in any orientation.



Load loss can be reduced and electrical energy efficiency can be improved by increasing the cross section of copper coils. Hence Polycab's high efficiency motor use higher amount of copper in the winding.



The highest grade of pure copper, also known as electrolytic grade copper, is used for motor winding in Polycab fans. It is thermostatically balanced, maximizes electrical conductivity and is highly efficient.



Polycab fans use a highly specialized protective layer that makes the fan blades rust proof and prevents corrosion.



A uniquely engineered motor that emits low heat even after running for hours. This greatly enhances the motor's efficiency.



The totally enclosed and ruggedly built heavy duty motor ensures high performance and delivers maximum output at lower operating cost.



The intelligently designed fan blades consistently push cool air downwards. The asymmetric alignment of the blades coupled with higher blade width ensures maximum air delivery.



The aerodynamically designed blades reduce the drag from air and maximize air delivery.



Count on Aura LED to add some extra touch of style to your home decor. A perfect union of innovation and creativity found as distinctive feature in Polycab designer range of fans. Aura LED makes every room lively, aesthetically pleasing and uplifts the ambience as per your mood with its multi-coloured LED mood lights.

CEILING FANS



SUPER PREMIUM FANS



SUPERIA LITE SP01



SUPERIA LITE SP01 WITH REMOTTE
ANTIQUÉ COPPER ROSEWOOD

Also available in:

Matt White | Matt Dark Brown | Matt Brass Dark wood | Antique Silver Dark wood

Superia is an everlasting expression of the exceptional. Embellished with new-age comforts and old world panache, This Superia designer fan has all it takes to be the star attraction of your home. Aura multi-coloured LED light to uplift your mood, remote-controlled operation and a timeless antique finish are just a few of the many features that make this fan the ultimate expression of urban luxury.



SWEEP (MM) 1200	POWER INPUT (W) 75	SPEED (RPM) 340	AIR DELIVERY (CMM) 210
---------------------------	------------------------------	---------------------------	----------------------------------



SUPERIA LITE SP02



SUPERIA LITE SP02 WITH UN DERLIGHTS
ANTIQUE COPPER ROSEWOOD



Also available in:
Antique matt brass dark wood | Antique silver dark wood
White chrome | Black Chrome

Superia is an everlasting expression of the exceptional. Embellished with new-age comforts and old world panache, This Superia designer fan has all it takes to be the star attraction of your home. Underlight fan to uplift your mood, Tri Speed, Clip-on lights and a timeless antique finish are just a few of the many features that make this fan the ultimate expression of urban luxury.

SWEEP (MM) 1200	POWER INPUT (W) 75	SPEED (RPM) 340	AIR DELIVERY (CMM) 210
---------------------------	------------------------------	---------------------------	----------------------------------

ANTI-RUST |
 STAY COOL MOTOR |
 HIGH AIR COVERAGE |
 ROBUST MOTOR |
 100% QUALITY CHECK |
 MAX AIR TECHNOLOGY |
 TRI SPEED |
 CLIP-ON LIGHTS

SUPERIA LITE SP03



SUPERIA LITE SP03 WITH REMOTTE
ANTIQUE COPPER ROSEWOOD

Also available in:

Antique matt brass dark wood | Antique silver dark wood
White chrome | Black Chrome

Superia is an everlasting expression of the exceptional. Embellished with new-age comforts and old world panache, This Superia designer fan has all it takes to be the star attraction of your home. Aura multi-coloured LED light to uplift your mood, remote-controlled operation and a timeless antique finish are just a few of the many features that make this fan the ultimate expression of urban luxury.



SWEEP (MM) 800	POWER INPUT (W) 70	SPEED (RPM) 340	AIR DELIVERY (CMM) 200
--------------------------	------------------------------	---------------------------	----------------------------------



SUPERIA LITE SP04

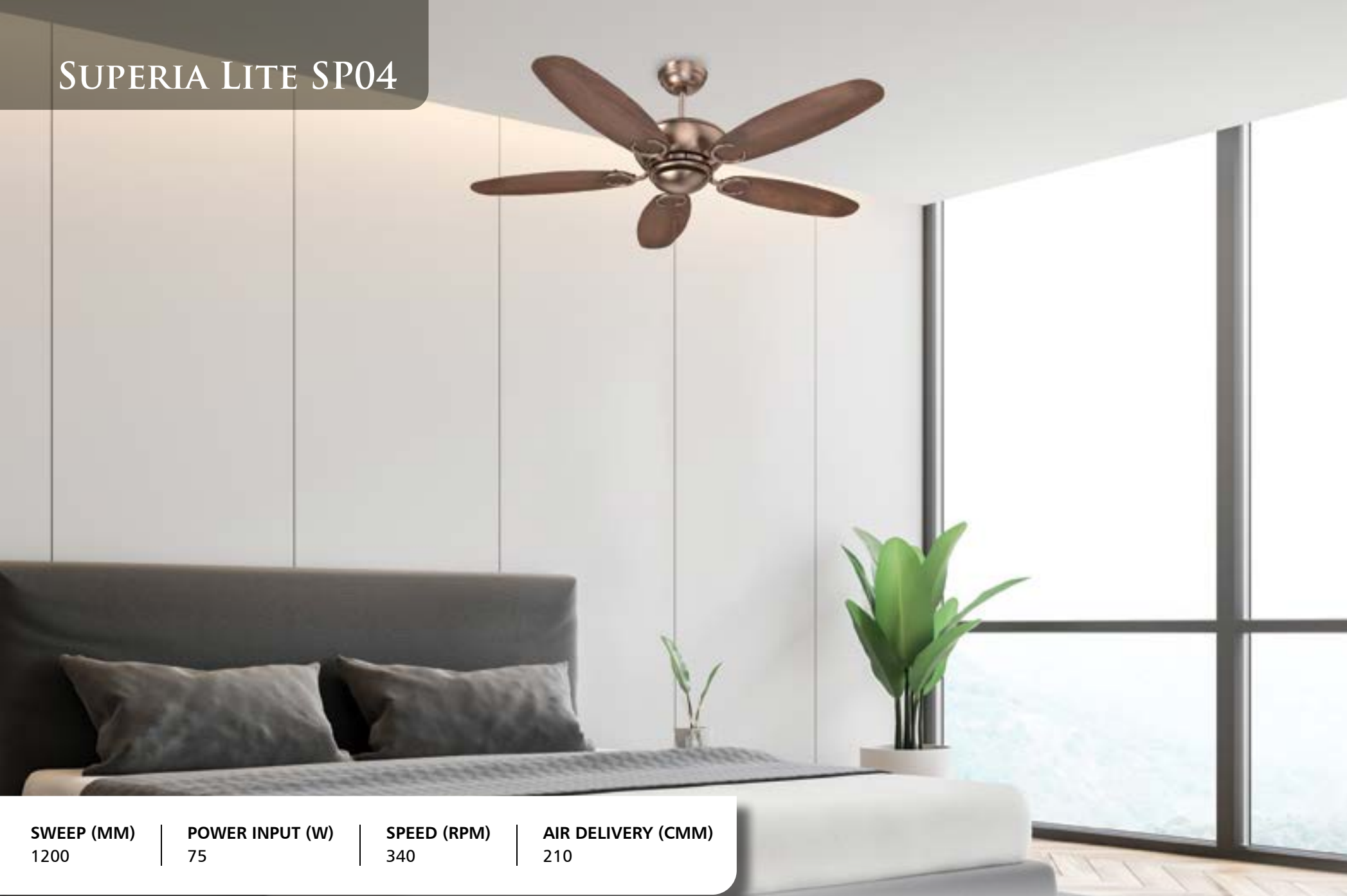

SWEEP (MM) 1200	POWER INPUT (W) 75	SPEED (RPM) 340	AIR DELIVERY (CMM) 210
---------------------------	------------------------------	---------------------------	----------------------------------



SUPERIA LITE SP04
ANTIQUÉ COPPER ROSEWOOD



Also available in:
Antique matt brass dark wood | Antique silver dark wood
White chrome | Black Chrome

Mesmerising looks coupled with aerodynamic design makes this luxury fan both a visual treat and your ultimate comfort partner. While Superia's impressive airflow technology delivers air to every corner of the room, it's unique aesthetics complement all types of ceilings, modern or traditional.

SUPERIA LITE SP05



SUPERIA LITE SP05
ANTIQUE COPPER ROSEWOOD

Also available in:

Antique matt brass dark wood | Antique silver dark wood
White chrome | Black Chrome

Mesmerising looks coupled with aerodynamic design makes this luxury fan both a visual treat and your ultimate comfort partner. While Superia's impressive airflow technology delivers air to every corner of the room, it's unique aesthetics complement all types of ceilings, modern or traditional.



SWEEP (MM) 1200	POWER INPUT (W) 75	SPEED (RPM) 340	AIR DELIVERY (CMM) 210
---------------------------	------------------------------	---------------------------	----------------------------------



SUPERIA LITE SP06

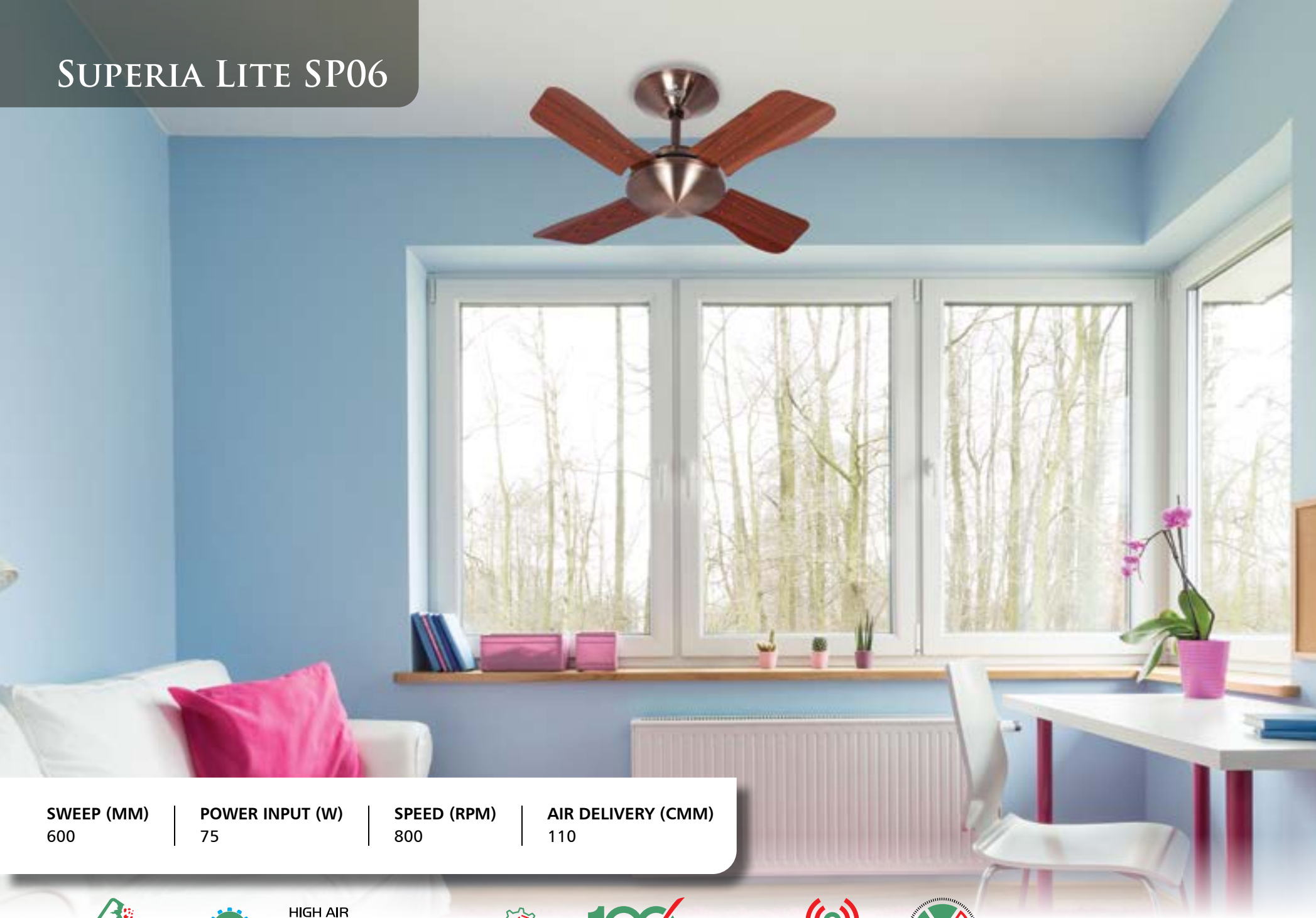

SWEEP (MM)	POWER INPUT (W)	SPEED (RPM)	AIR DELIVERY (CMM)
600	75	800	110



ANTI-RUST



STAY COOL MOTOR



HIGH AIR COVERAGE



ROBUST MOTOR



100% QUALITY CHECK



MAX AIR TECHNOLOGY



HIGH SPEED



SUPERIA LITE SP0 6
ANTIQUÉ COPPER ROSEWOOD

Also available in:
Antique matt brass dark wood | Antique silver dark wood
White chrome | Black Chrome

Mesmerising looks coupled with aerodynamic design makes this luxury fan both a visual treat and your ultimate comfort partner. This fan is ideal for study rooms & smaller work spaces. While Superia's impressive airflow technology delivers air to every corner of the room, it's unique aesthetics complement all types of ceilings, modern or traditional.

SUPERIA LITE SP07

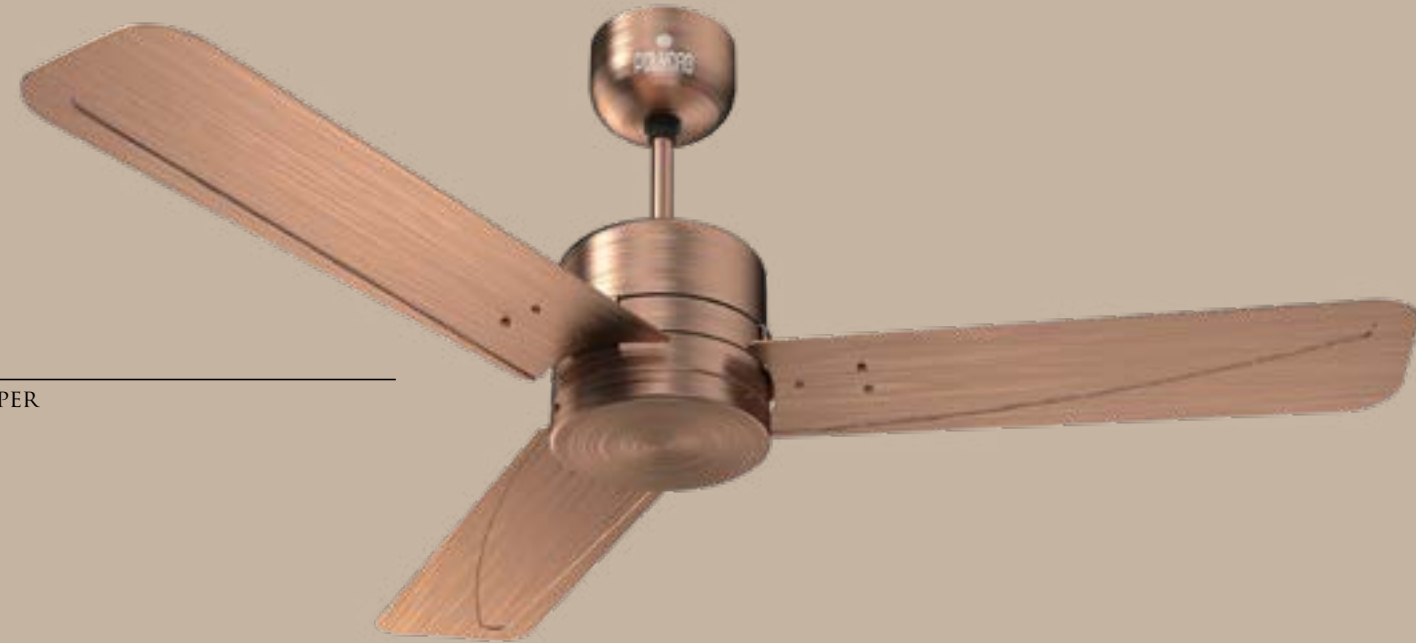

SUPERIA SP07
BRUSHED COPPER

Also available in:

Antique matt brass dark wood | Antique silver dark wood | White chrome | Black Chrome

Mesmerising looks coupled with aerodynamic design makes this luxury fan both a visual treat and your ultimate comfort partner. While Superia's impressive airflow technology delivers air to every corner of the room, it's unique aesthetics complement all types of ceilings, modern or traditional.



SWEEP (MM)	POWER INPUT (W)	SPEED (RPM)	AIR DELIVERY (CMM)
1200	75	340	210



PUROCOAT FANS



4in1 PROTECTION



ANTI - DUST



ANTI - RUST



ANTI - FADE



ANTI - BACTERIA





Polycab Purocoat Fans with 4-in-1 Protection*

Extensive research and several real-world tests have led to the development of NANOVA HYGIENE+™ - An anti-microbial surface coating with low surface energy value and active chemicals that repels and neutralizes viruses, microbes and other deadly pathogens.

NANOVA technology is the effective combination of Metal Nano Particles a virucidal and nonmigratory Quaternary Ammonium Salt (QuAT) a virostatic material dispersed homogeneously in a functional polymer matrix and works on surface contact mechanism. When microbes like viruses, bacteria or any other germs come in contact with the coated surfaces of fan, the nano active molecules QuAT present in the coating effectively deactivate the outer layer protein of the microbes and the Metal Nano Particle effectively disintegrate the DNA or RNA genomes preventing its chance of replication. NANOVA HYGIENE+™ based technology tested successfully against bacteria and virus (as mentioned in the reports) from third party lab and it showed an efficacy of >99%* when tested as per global standards of ISO 21702:2019 and JIS Z 2801:2010.

Several other scientific publications have also opined that the present nano molecules could be equally effective against a broad spectrum of viruses as well.

*Tested under standard laboratory condition in a third party lab.

*This product is not a substitute to the mandatory precautions prescribed by the governments such as wearing masks, social distancing, usage of hand sanitizers & surface hygiene practices etc.

*Claim not applicable to coronavirus (COVID-19).

How does the coating work?

The cationic metal ion (Ag+) or non-migratory Quaternary Ammonium Salt works to deactivate the surface protein based on its charge.

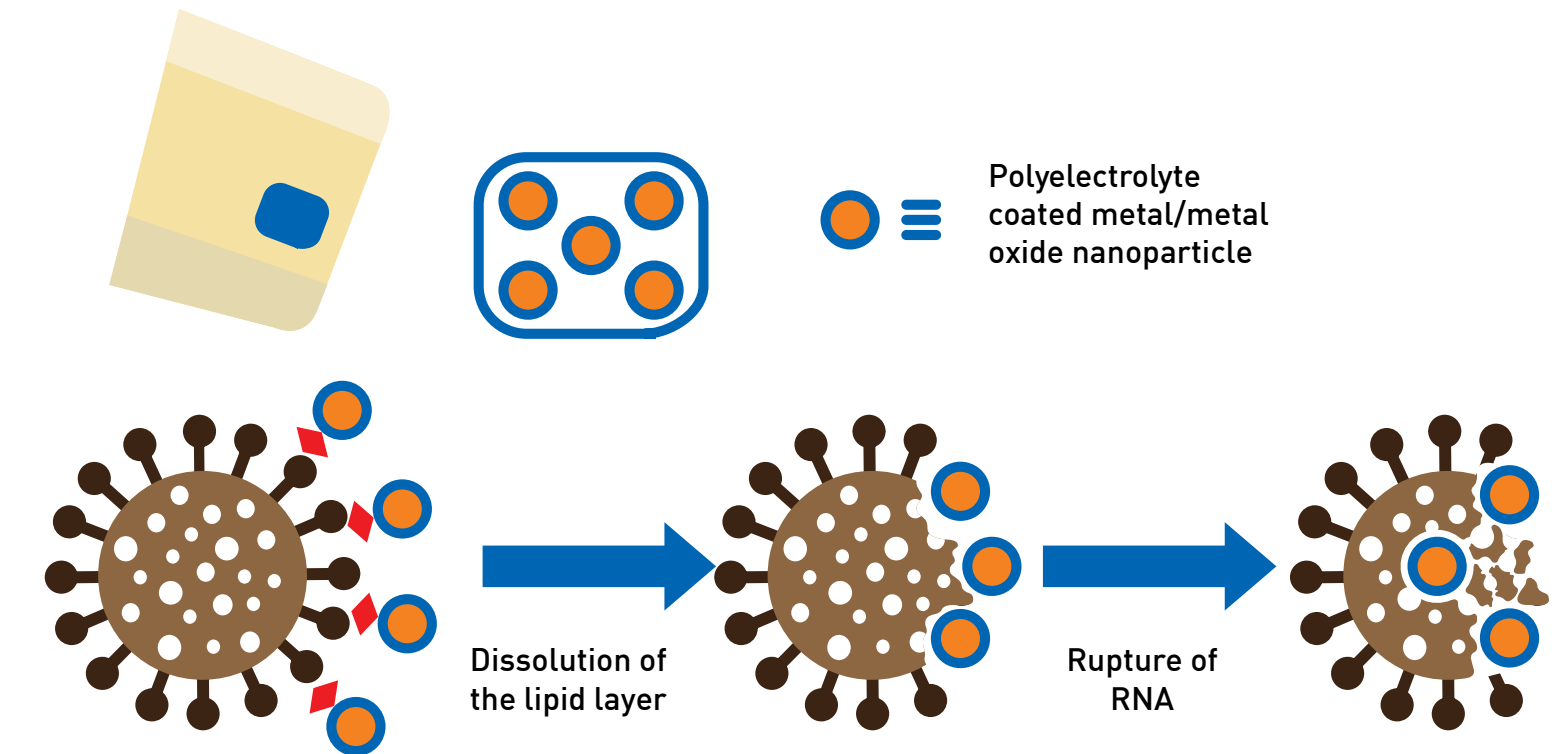

1. Interaction of silver nanoparticles with HIV-1. *J Nano biotechnology*. 2005, 3(6), 6.
2. Silver nanoparticles as potential antiviral agents, *Molecules*. 2011, 16(10), 8894-918
3. Claim not applicable to coronavirus (COVID-19).

Four-in-one protection

Anti Bacteria

Ordinary fans Polycab PuroCoat fans

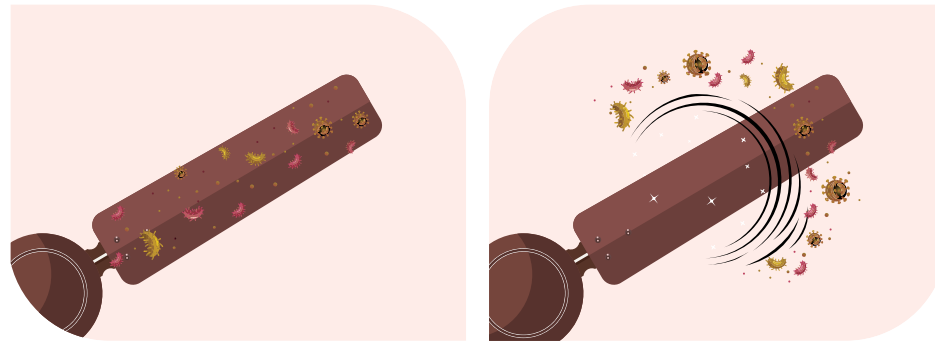

These disease-causing threats don't stand a chance against Polycab's PuroCoat fans. In addition to eliminating 99% bacteria, the bioactive nano particles present in the coating also keeps the indoor environment clean.

Pathogens

Disinfected Zone

Anti Fade

Ordinary fans Polycab PuroCoat fans

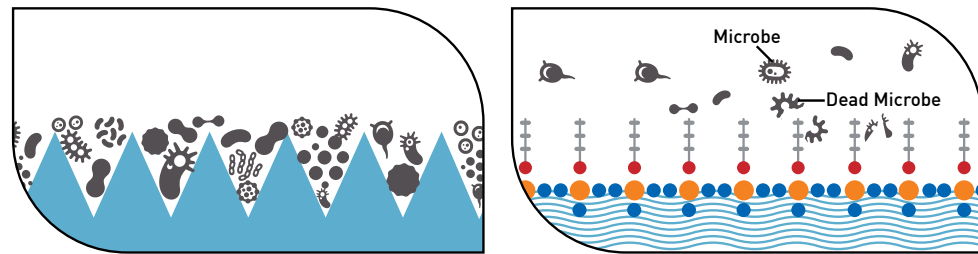

Cross section of contaminated surface

Protected Surface

The advance coating protects the painted surface from the effects of weather and retains the original shine for a longer duration the fan will look as good as new for years.

*Claim not applicable to coronavirus (COVID-19).

Anti Dust

Ordinary fans Polycab PuroCoat fans

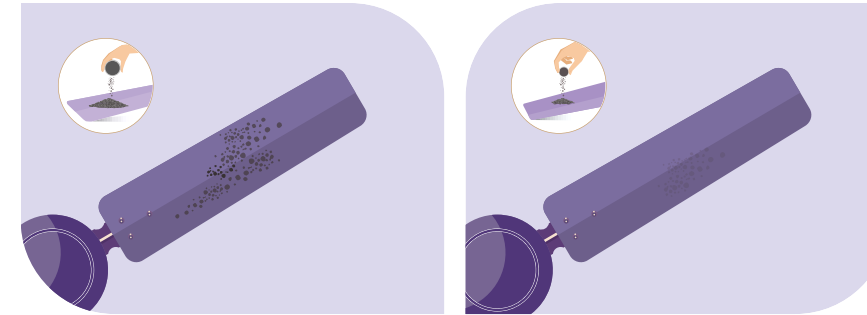

The advanced coating restricts dust particles (up to 50%) from accumulating on the fan's surface. These fans are also easy to clean – a single swipe is enough!

Anti Rust

Ordinary fans Polycab PuroCoat fans

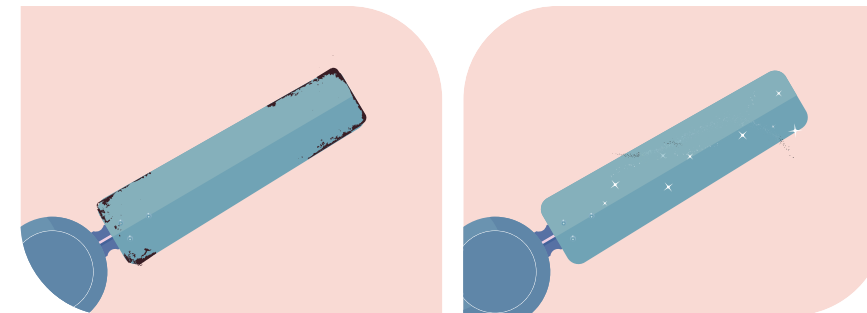

Due to high cross-linking density and presence of nano-domain in the backbone, the cured polymer film has excellent mechanical properties and excellent chemical resistant (anti-corrosion) properties. This prevents the corrosion of the fan blade edges.

Bring Polycab PuroCoat fans home and give your family the protection they deserve.



Certification*

NANOVA HYGIENE+™ - based technology tested successfully against bacteria (as mentioned in the reports) from third party lab and it showed an efficacy of >99%* when tested as per global standards of ISO 21702:2019 and JIS Z 2801:2010.



BTS BIOTECH TESTING SERVICES	
TEST REPORT	
LAB NO. : 198571-5	DATE: 20/08/20
NAME OF CUSTOMER	: M/S. POLYCARB INDA LIMITED
ADDRESS	: Polycarb House, T1, Magul Lane, Malviya 2nd, Mumbai 400016, Maharashtra, India
REFERENCE	: Your Letter Ref. No dated June 23, 2019
DATE OF RECEIPT	: 20/08/20
DATE OF INTIMATION	: 20/08/20
DATE OF COMPLETION	: 20/08/20
SAMPLE DESCRIPTION	: Panel sample specimen labeled as -
Sl. No.	Sample Code
1	LA TROUSERS-ESP 140X 48 (Anti-bac. anti-bacterial easy to clean nano coating)
2	Lab Control - Uncoated
Name of Test: Evaluation of Antimicrobial Activity of Panel samples	
Name of Test Protocol: ISO 21702:2019	
Test Organisms used for evaluating Antimicrobial activity: 1. Staphylococcus aureus ATCC 8328 2. Escherichia coli ATCC 8739	
Test Conditions: Neutraliser used : Buffered Saline with Tween 80 - 0.2% v/v Contact Time : 24 hours at 37°C Incubation Temperature : 37°C for Bacteria Media and Reagents : Spectrophotometer (light agar) for Bacteria	
Page 1 of 2	
<small>* Samples are not shown for the laboratory. ** Result valid only for the sample tested. * The report shall not be reproduced except in full without prior permission of this laboratory. 324/101, Malviya, Maharashtra Ind. Estate, L.B.S. Marg, Chhatrapati (S), Mumbai - 400016, INDIA. * Tel: +91 22 2508 2811, 2508 2812 Email: info@btsindia.in / export@btsindia.in / btsindiatech@btsindia.in / btsindiatech@gmail.com / btsindiatech@btsindia.in An ISO 17025:2017 Accredited Testing Services www.btsindia.in</small>	

BTS BIOTECH TESTING SERVICES	
TEST REPORT	
LAB NO. : 201906 1-2	DATE: 19/08/20
NAME OF CUSTOMER	: M/S. POLYCARB INDA LIMITED
ADDRESS	: Polycarb House, T1, Magul Lane, Malviya 2nd, Mumbai 400 016
REFERENCE	: Your Letter Ref. No dated April 24, 2020 Your Member: Dr. Laxmi Wadga
DATE OF RECEIPT	: 19/08/20
DATE OF INTIMATION	: 20/08/20
DATE OF COMPLETION	: 19/08/20
SAMPLE DESCRIPTION	: Coated sample labeled as -
Sl. No.	Sample Code
1	CONTROL
2	NANOVA ULTRAGUARD ESP 140X 48
Uncoated lab control	
Name of Test: Measurement of Antimicrobial activity on plastic and other non-porous surfaces	
Name of Test Protocol: ISO 21702:2019	
Scope of Method: This test specifies method for measuring antimicrobial activity on plastic and other non-porous surface of antimicrobial products against specified virus. Due to individual sensitivities, the results of one test virus might not be applicable to other viruses.	
*Modified method with use of MS2 virus	
Page 1 of 2	
<small>* Samples are not shown for the laboratory. ** Result valid only for the sample tested. * The report shall not be reproduced except in full without prior permission of this laboratory. 324/101, Malviya, Maharashtra Ind. Estate, L.B.S. Marg, Chhatrapati (S), Mumbai - 400016, INDIA. * Tel: +91 22 2508 2811, 2508 2812 Email: info@btsindia.in / export@btsindia.in / btsindiatech@btsindia.in / btsindiatech@gmail.com / btsindiatech@btsindia.in An ISO 17025:2017 Accredited Testing Services www.btsindia.in</small>	

*Tested under standard laboratory condition in a third party lab.
 *This product is not a substitute to the mandatory precautions prescribed by the government such as wearing masks, social distancing, usage of hand sanitizers & surface hygiene practices etc.
 *Claim not applicable to coronavirus (COVID-19).



SWEEP (MM) 1200	POWER INPUT (W) 75	SPEED (RPM) 400	AIR DELIVERY (CMM) 230
---------------------------	------------------------------	---------------------------	----------------------------------



4in1 PROTECTION PUROCOAT



AEREO PUROCOAT
MATT BLACK CHOCOLATE GOLD



Copper Champagne Gold



Lilac Silver



Metallic Warm Grey



Pearl White Cloud Grey Silver



Seal Brown

EUPHORIA- EP01



SWEEP (MM) 1200	POWER INPUT (W) 75	SPEED (RPM) 400	AIR DELIVERY (CMM) 230
---------------------------	------------------------------	---------------------------	----------------------------------

- GH SPEED
- DOUBLE BALL BEARING
- EXTRA COPPER
- LOW DRAG BLADE TECHNOLOGY
- ROBUST MOTOR

- ANTI-DUST
- ANTI-RUST
- ANTI-FADE
- ANTI-BACTERIA

4i1 PROTECTION PUROCOAT



EUPHORIA EP01 PUROCOAT
SEA BLUE SILVER

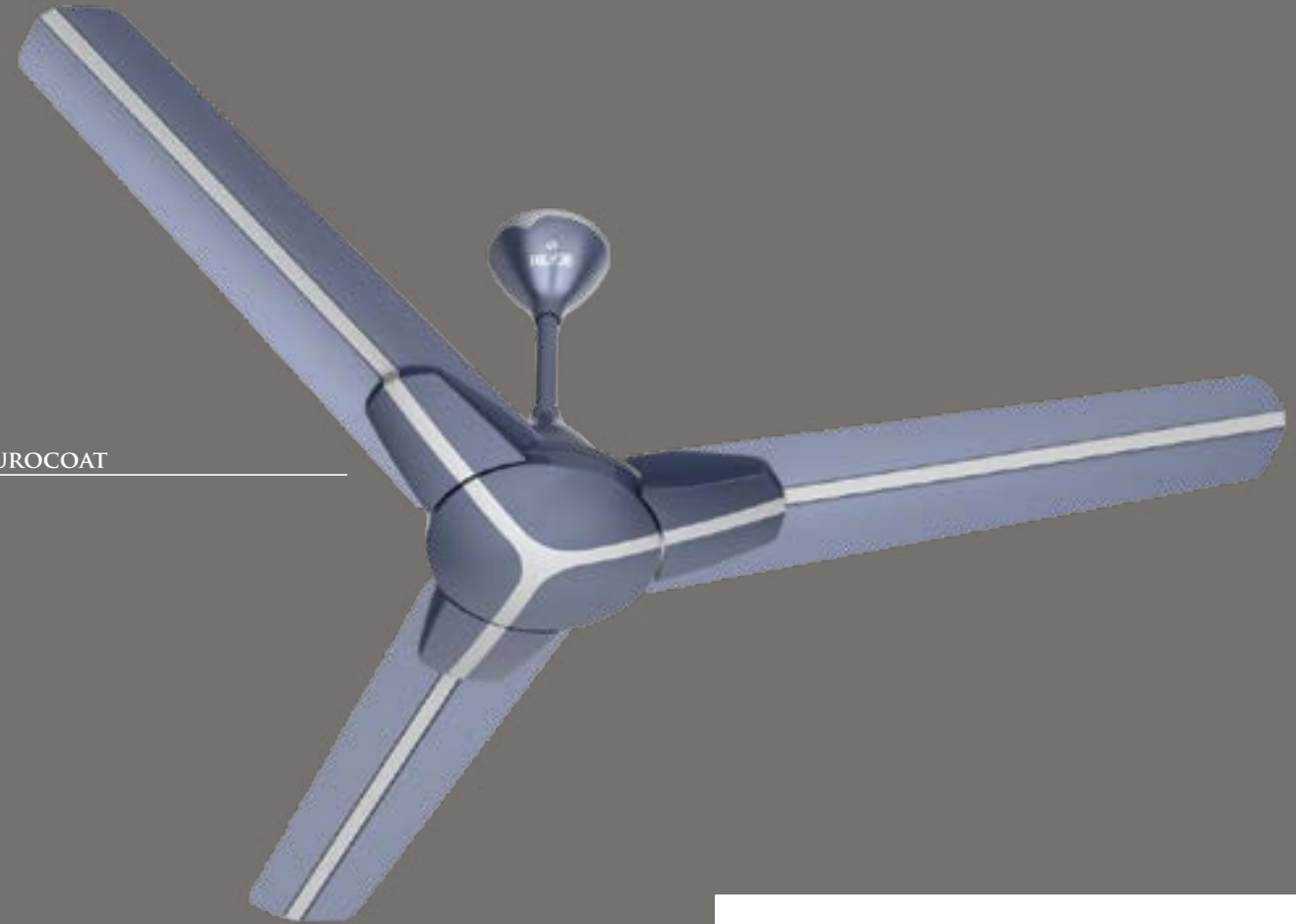

Mystic Magenta Silver



Neutral Resort Brown



White Midnight Blue

EUPHORIA- EP02

EUPHORIA EP02 PUROCOAT
WHITE MIDNIGHT BLUE

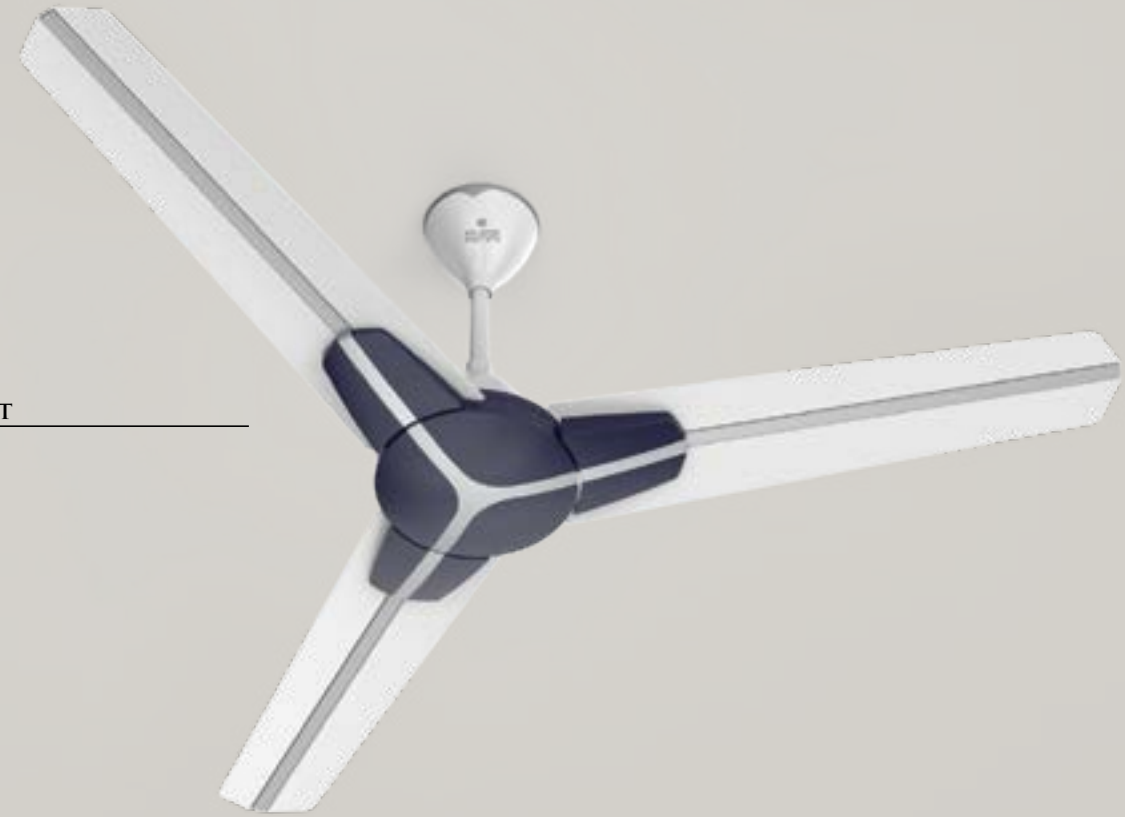

Mystic Magenta Silver

Neutral Resort Brown

Sea Blue Silver



SWEEP (MM) 1200	POWER INPUT (W) 75	SPEED (RPM) 400	AIR DELIVERY (CMM) 230
---------------------------	------------------------------	---------------------------	----------------------------------



HIGH SPEED



DOUBLE BALL BEARING



EXTRA COPPER



LOW DRAG BLADE TECHNOLOGY



ROBUST MOTOR



ANTI - DUST



ANTI - RUST



ANTI - FADE



ANTI - BACTERIA

4in1 PROTECTION PUROCOAT



TRYST PUROCOAT
MIDNIGHT BLUE- SILVER

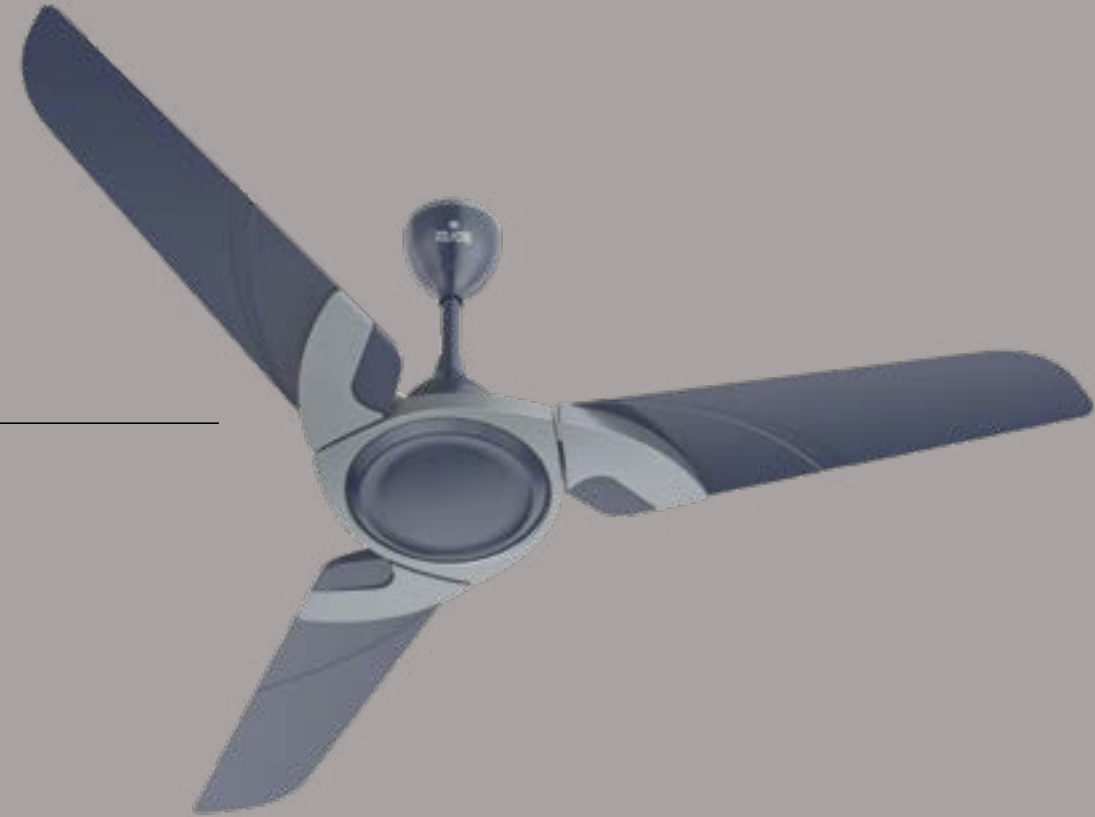

Camel Cocoa Brow



Champagne Gold



Pearl White Sea Blue



Sand Storm-Rose Gold



SWEEP (MM)	POWER INPUT (W)	SPEED (RPM)	AIR DELIVERY (CMM)
1200	75	400	230



HIGH SPEED



DOUBLE BALL BEARING



EXTRA COPPER



LOW DRAG BLADE TECHNOLOGY



ROBUST MOTOR



ANTI - DUST



ANTI - RUST



ANTI - FADE



ANTI - BACTERIA

4ⁱⁿ1 PROTECTION PUROCOAT



REVERE



SWEEP (MM) 1200	POWER INPUT (W) 75	SPEED (RPM) 400	AIR DELIVERY (CMM) 230
---------------------------	------------------------------	---------------------------	----------------------------------



4ⁱⁿ1 PROTECTION PUROCOAT

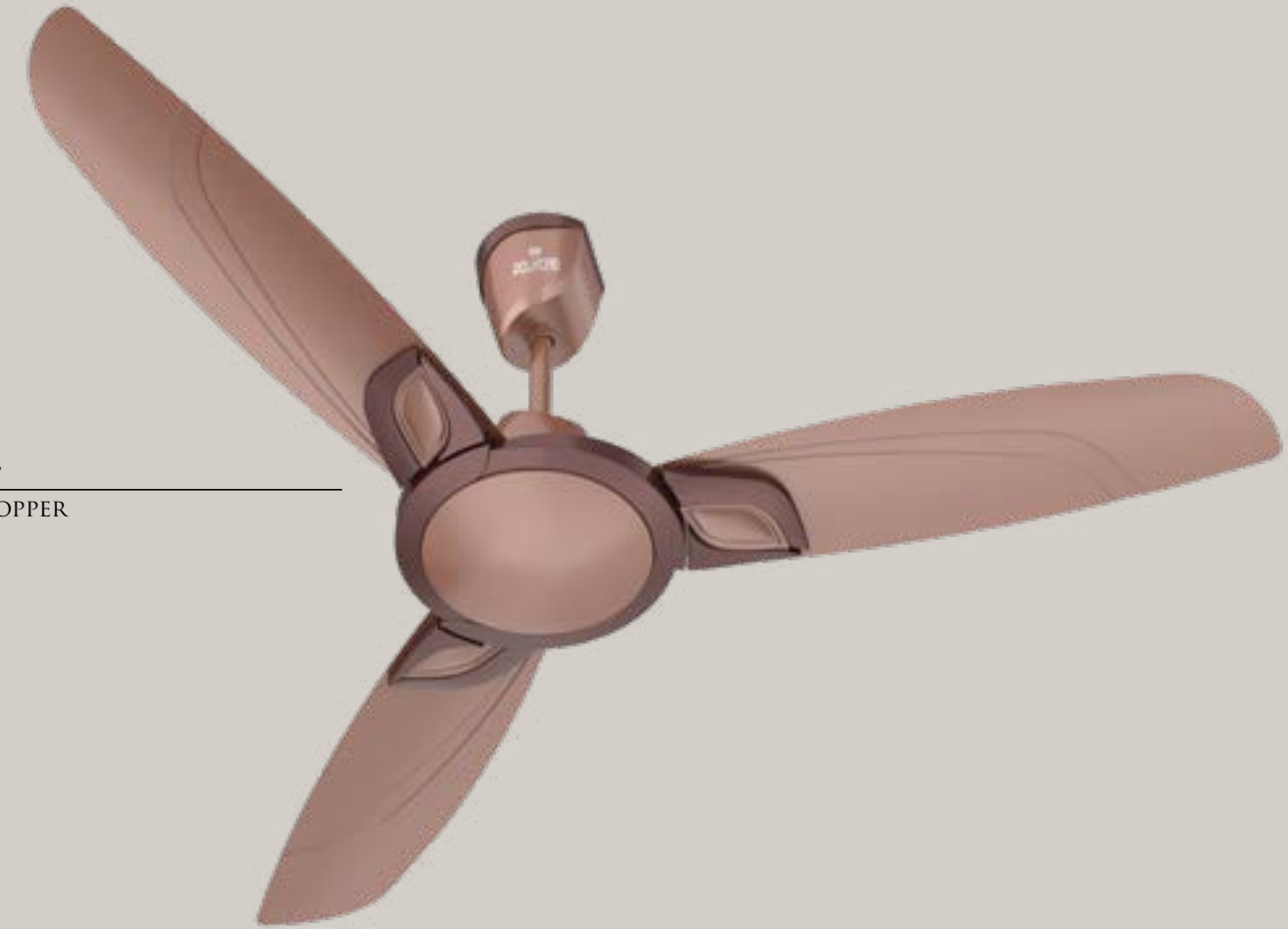

REVERE PUROCOAT
NATURAL WARM COPPER



Techno Purple



Bronze Gold



Vine Grape



White Rose Silver

ASPIRE PUROCOAT
TECHNO BLACK GOLD

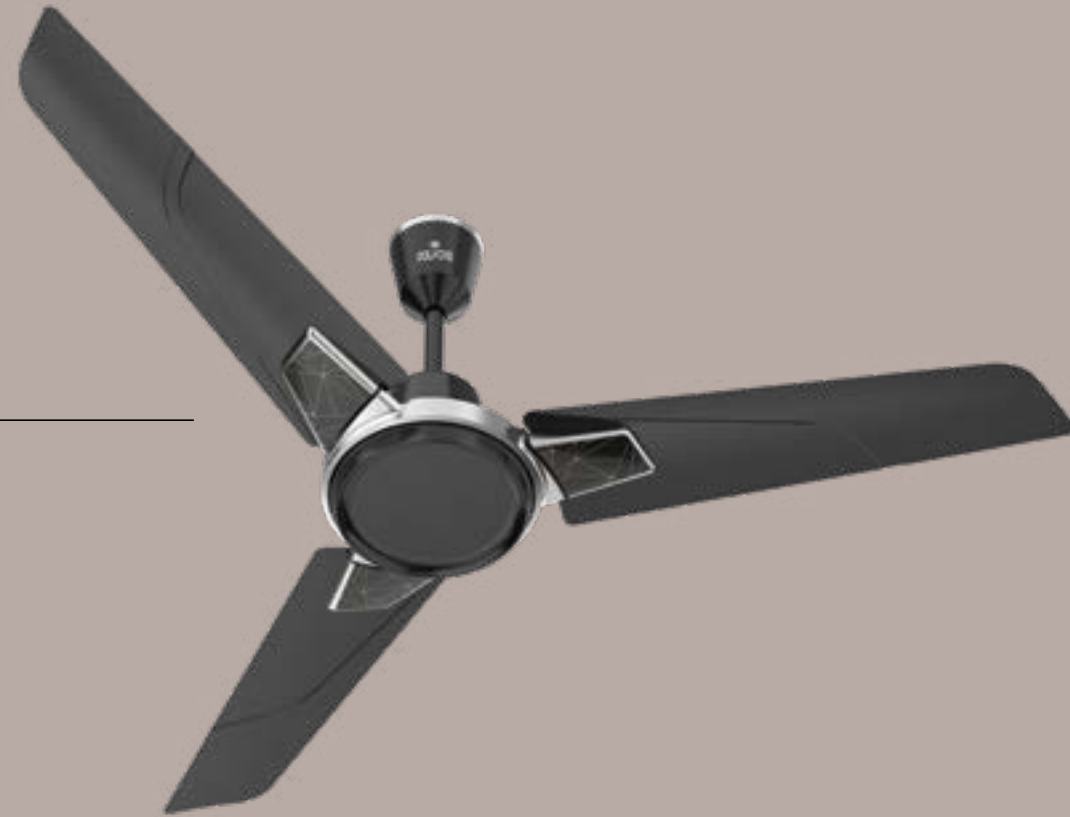

Cool Grey Silver

English Lavender

Pearl White God



SWEEP (MM) 1200	POWER INPUT (W) 75	SPEED (RPM) 400	AIR DELIVERY (CMM) 230
---------------------------	------------------------------	---------------------------	----------------------------------

- HIGH SPEED
- DOUBLE BALL BEARING
- EXTRA COPPER
- LOW DRAG BLADE TECHNOLOGY
- ROBUST MOTOR

- ANTI - DUST
- ANTI - RUST
- ANTI - FADE
- ANTI - BACTERIA
- 4in1 PROTECTION**
- PUROCOAT**



ELEGANZ PUROCOAT

ELEGANZ PUROCOAT
PEARL WHITE

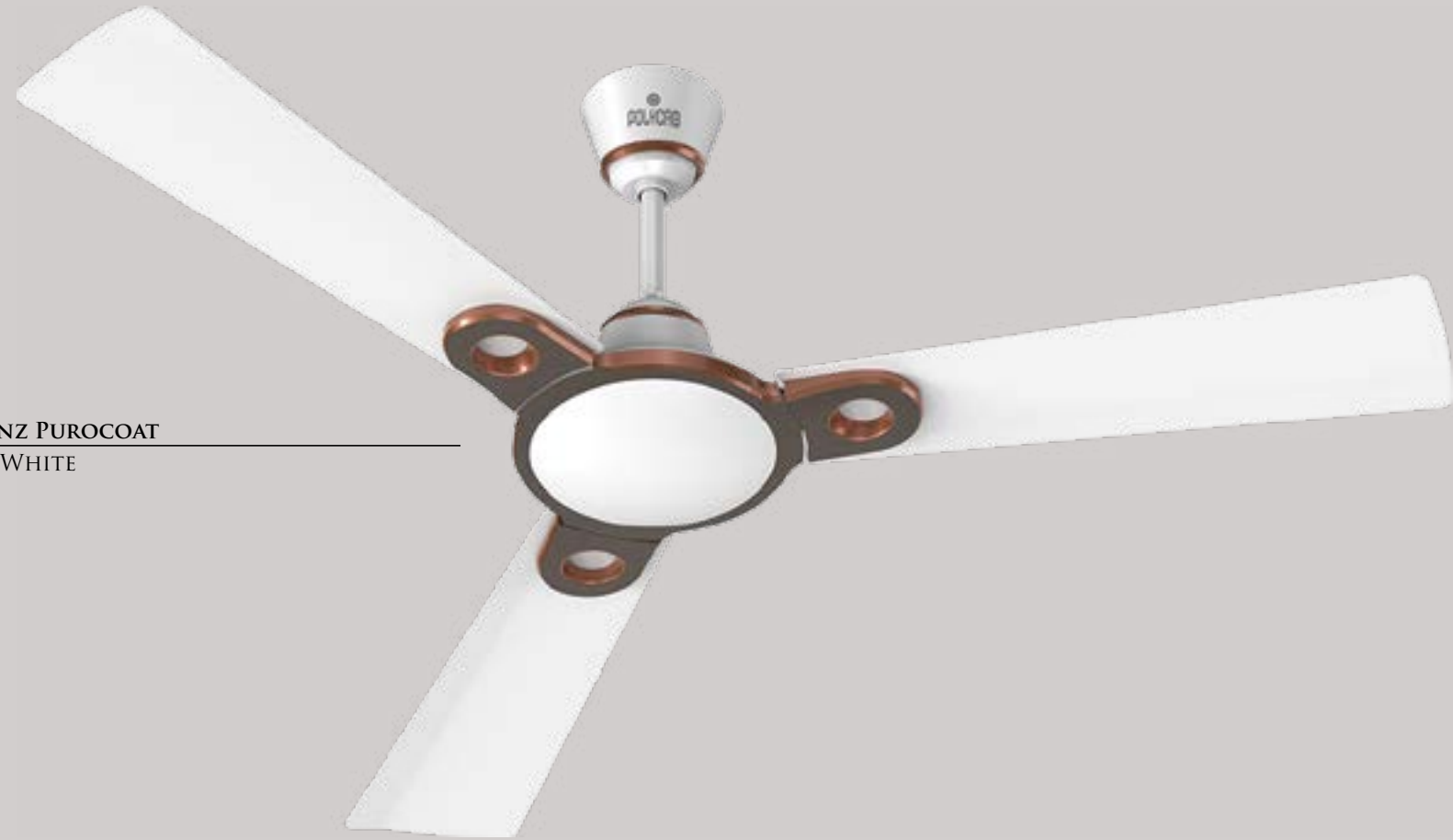

Pearl Gold mist



Pearl Silver



Pearl Indigo Blue



Espresso Brown



SWEEP (MM) 1200 / 900	POWER INPUT (W) 75 / 70	SPEED (RPM) 400 / 440	AIR DELIVERY (CMM) 230 / 150
---------------------------------	-----------------------------------	---------------------------------	--



GH SPEED



DOUBLE BALL BEARING



EXTRA COPPER



LOW DRAG BLADE TECHNOLOGY



ROBUST MOTOR



ANTI-DUST



ANTI-RUST



ANTI-FADE



ANTI-BACTERIA

4in1 PROTECTION PUROCOAT



ELEGANZ D-ZINER PUROCOAT



SWEEP (MM) 1200	POWER INPUT (W) 75	SPEED (RPM) 400	AIR DELIVERY (CMM) 235
---------------------------	------------------------------	---------------------------	----------------------------------



4in1 PROTECTION PUROCOAT



ELEGANZ D-ZINER PUROCOAT
ESPRESSO BROWN



Also available in

● Indigo blue

● Birkin Gold

ELEGANZ FLORAL PUROCOAT

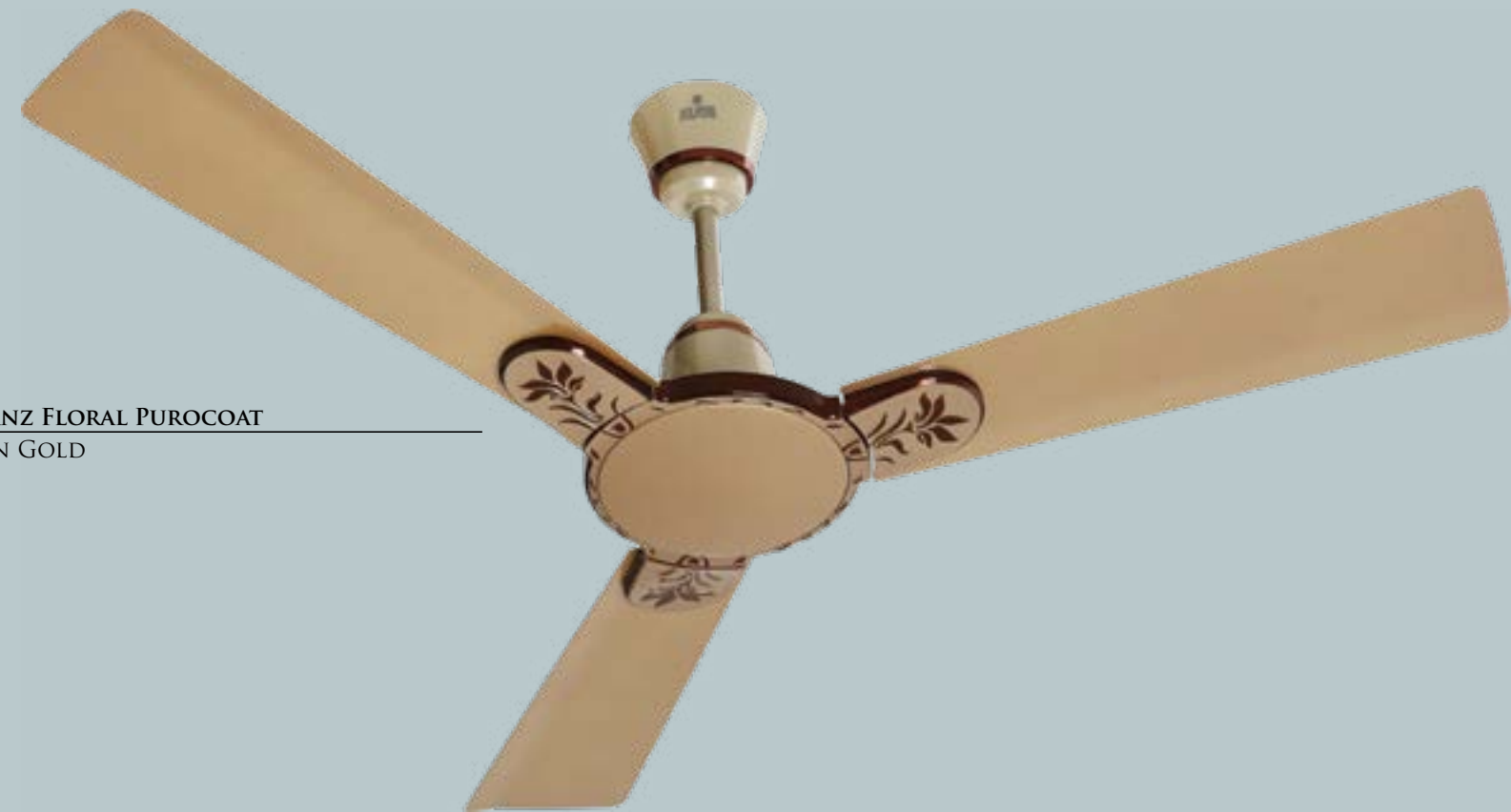

ELEGANZ FLORAL PUROCOAT
BIRKIN GOLD



Pearl White



Indigo Blue



SWEEP (MM) 1200	POWER INPUT (W) 75	SPEED (RPM) 400	AIR DELIVERY (CMM) 235
---------------------------	------------------------------	---------------------------	----------------------------------



HIGH SPEED



DOUBLE BALL BEARING



EXTRA COPPER



LOW DRAG BLADE TECHNOLOGY



ROBUST MOTOR



ANTI - DUST



ANTI - RUST



ANTI - FADE



ANTI - BACTERIA

4in1 PROTECTION PUROCOAT



PREMIUM FANS





SWEEP (MM)	POWER INPUT (W)	SPEED (RPM)	AIR DELIVERY (CMM)
1200	75	400	235

- HIGH SPEED
- DOUBLE BALL BEARING
- STAY COOL MOTOR
- 7 TANK CLEANING & RE-DUSTING
- 3 STEP PAINT
- EXTRA COPPER
- ROBUST MOTOR
- MPMV
Max Performance Minimum Voltage
- HIGH AIR COVERAGE
- 99.9% PURE COPPER
- MAX AIR TECHNOLOGY
- LOW DRAG BLADE TECHNOLOGY
- 100% QUALITY CHECK
- MULTI-FINISH
- ANTI-RUST



ELIANA
PEARL WHITE

Also available in:

- Indigo Blue
- Espresso Brown



Birkin Gold

METALLICA

METALLICA
ANTIQUE COPPER



Brush Steel



Antique Brass



SWEEP (MM)	POWER INPUT (W)	SPEED (RPM)	AIR DELIVERY (CMM)
1200	75	400	235



DOUBLE BALL BEARING



STAY COOL MOTOR



7 TANK CLEANING & RE-DUSTING



3 STEP PAINT



EXTRA COPPER



ROBUST MOTOR



MPMV
Max Performance Minimum Voltage



HIGH AIR COVERAGE



99.9% PURE COPPER



MAX AIR TECHNOLOGY



LOW DRAG BLADE TECHNOLOGY



100% QUALITY CHECK



MULTI-FINISH



ANTI-RUST



VITAL PLATINUM



SWEEP (MM)	POWER INPUT (W)	SPEED (RPM)	AIR DELIVERY (CMM)
1200	75	400	235

- HIGH SPEED**
- DOUBLE BALL BEARING**
- STAY COOL MOTOR**
- 7 TANK CLEANING & RE-DUSTING**
- 3 STEP PAINT**
- EXTRA COPPER**
- ROBUST MOTOR**
- MPMV**
Max Performance Minimum Voltage
- HIGH AIR COVERAGE**
- 99.99% PURE COPPER**
- MAX AIR TECHNOLOGY**
- LOW DRAG BLADE TECHNOLOGY**
- 100% QUALITY CHECK**
- MULTI-FINISH**
- ANTI-RUST**

VITAL PLATINUM
ANTIQUE COPPER

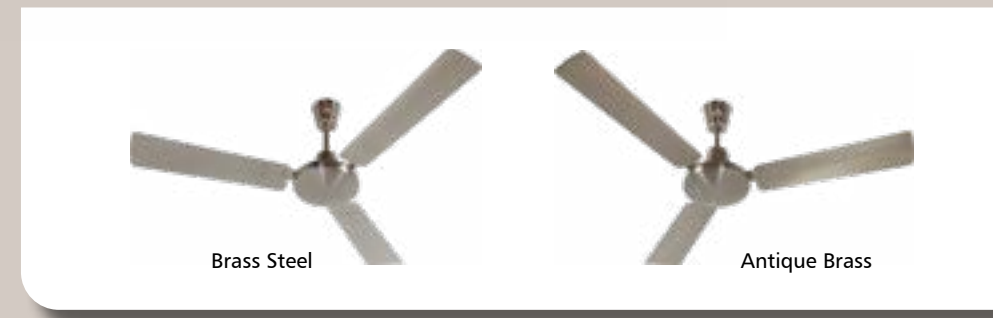

CRYSTAL PUROCOAT
PEARL BEIGE



SWEEP (MM)	POWER INPUT (W)	SPEED (RPM)	AIR DELIVERY (CMM)
1400 / 1200 / 900	75 / 75 / 70	290 / 400 / 440	250 / 235 / 150

Also available in:

- Pearl Pink
- Pearl Ivory
- Pearl Blue



INDIA GLORY



SWEEP (MM)	POWER INPUT (W)	SPEED (RPM)	AIR DELIVERY (CMM)
1200	75	400	235

- HIGH SPEED
- DOUBLE BALL BEARING
- STAY COOL MOTOR
- 7 TANK CLEANING & RE-DUSTING
- 3 STEP PAINT
- EXTRA COPPER
- ROBUST MOTOR
- MPMV Max Performance Minimum Voltage
- HIGH AIR COVERAGE
- 99.9% PURE COPPER
- MAX AIR TECHNOLOGY
- LOW DRAG BLADE TECHNOLOGY
- 100% QUALITY CHECK
- MULTI-FINISH
- ANTI-RUST

INDIA GLORY PUROCOAT
PEARL IVORY



Also available in:

- Pearl Jasmine
- Pearl White
- Pearl Silver
- Pearl Brown

STUNNER

STUNNER
INDIGO BLUE



Espresso Brown

Also available in:

- Ocean Green
- Matt Black



SWEEP (MM)	POWER INPUT (W)	SPEED (RPM)	AIR DELIVERY (CMM)
1200	75	400	235

DOUBLE BALL BEARING	STAY COOL MOTOR	7 TANK CLEANING & RE-DUSTING	3 STEP PAINT	EXTRA COPPER	ROBUST MOTOR	MPMV Max Performance Minimum Voltage
HIGH AIR COVERAGE	99.9% PURE COPPER	MAX AIR TECHNOLOGY	LOW DRAG BLADE TECHNOLOGY	100% QUALITY CHECK	MULTI-FINISH	ANTI-RUST



ELANZA

ELANZA
PEARL WHITE



Pearl Brown



Pearl Ivory



Pearl Blue

Also available in:

- Pearl Copper
- Birkin Gold
- Pearl Matt Black

SWEEP (MM)	POWER INPUT (W)	SPEED (RPM)	AIR DELIVERY (CMM)
1400 / 1200 / 900	75 / 75 / 70	290 / 400 / 440	250 / 235 / 150



MPMV
Max Performance Minimum Voltage

BRIO

BRIO
PEARL BLUE



Pearl Brown



Pearl Ivory



Pearl Pink



Pearl White



SWEEP (MM) 1400 / 1200 / 900	POWER INPUT (W) 75 / 75 / 70	SPEED (RPM) 290 / 400 / 440	AIR DELIVERY (CMM) 250 / 235 / 150
--	--	---------------------------------------	--



HIGH AIR COVERAGE



99.9% PURE COPPER



MAX AIR TECHNOLOGY



LOW DRAG BLADE TECHNOLOGY



100% QUALITY CHECK



MULTI-FINISH



ANTI-RUST

EXTRA COPPER



SWEEP (MM)	POWER INPUT (W)	SPEED (RPM)	AIR DELIVERY (CMM)
1400 / 1200 / 900 / 600	75 / 75 / 70 / 75	290 / 400 / 440 / 800	250 / 235 / 150 / 120



99.9%
PURE COPPER



VITAL
PEARL BLUE

Also available in:

● Pearl Matt Black



Pearl Brown



Pearl Ivory



Pearl White



SWEEP (MM)	POWER INPUT (W)	SPEED (RPM)	AIR DELIVERY (CMM)
1400 / 1200	75 / 75	290 / 400	250 / 235



REGALIA PUROCOAT
IVORY PINK

Also available in:

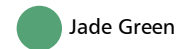

Woodland Silver



White Silver



Biege Woodland



Silver Red

ENERGY SAVER FANS



ELANZA PLUS



SWEEP (MM) 1200	POWER INPUT (W) 52	SPEED (RPM) 380	AIR DELIVERY (CMM) 225
---------------------------	------------------------------	---------------------------	----------------------------------



ELANZA PLUS
PEARL BROWN



Pearl White



Pearl Blue



Pearl Ivory

ZOOMER PLUS

ZOOMER PLUS
BROWN



Bianco

White

SWEEP (MM) 1200	POWER INPUT (W) 52	SPEED (RPM) 380	AIR DELIVERY (CMM) 225
---------------------------	------------------------------	---------------------------	----------------------------------

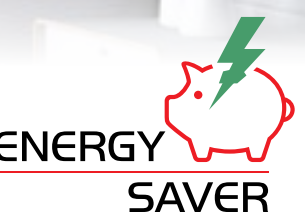

AFFECEIANTE NEO



AFFECIENTE NEO
WHITE



SWEEP (MM) 1200	POWER INPUT (W) 28	SPEED (RPM) 350	AIR DELIVERY (CMM) 220
---------------------------	------------------------------	---------------------------	----------------------------------



Also available in:
● Brown

HIGH SPEED	DOUBLE BALL BEARING	STAY COOL MOTOR	7 TANK CLEANING & RE-DUSTING	3 STEP PAINT	EXTRA COPPER	ROBUST MOTOR	MPMV Max Performance Minimum Voltage
HIGH AIR COVERAGE	99.9% PURE COPPER	MAX AIR TECHNOLOGY	LOW DRAG BLADE TECHNOLOGY	100% QUALITY CHECK	ANTI-RUST		

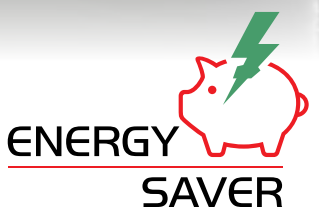

ARNE



POLYCARB



ARNE
WHITE



Brown

SWEEP (MM) 1200	POWER INPUT (W) 52	SPEED (RPM) 380	AIR DELIVERY (CMM) 225
---------------------------	------------------------------	---------------------------	----------------------------------



POWER SAVER 35 BLDC



POWER SAVER 35 BLDC
WHITE

SWEEP (MM) 1200	POWER INPUT (W) 35	SPEED (RPM) 350	AIR DELIVERY (CMM) 225
---------------------------	------------------------------	---------------------------	----------------------------------



DOUBLE BALL BEARING	STAY COOL MOTOR	7 TANK CLEANING & RE-DUSTING	3 STEP PAINT	EXTRA COPPER	ROBUST MOTOR	MPMV Max Performance Minimum Voltage
HIGH AIR COVERAGE	99.9% PURE COPPER	MAX AIR TECHNOLOGY	LOW DRAG BLADE TECHNOLOGY	100% QUALITY CHECK	MULTI-FINISH	ANTI-RUST



AFFECIENTE BLDC 32



AFFECIENTE
BROWN



SWEEP (MM) 1200	POWER INPUT (W) 32	SPEED (RPM) 350	AIR DELIVERY (CMM) 210
---------------------------	------------------------------	---------------------------	----------------------------------



 DOUBLE BALL BEARING	 STAY COOL MOTOR	 7 TANK CLEANING & RE-DUSTING	 3 STEP PAINT	 EXTRA COPPER	 ROBUST MOTOR	 MPMV Max Performance Minimum Voltage
 HIGH AIR COVERAGE	 99.9% PURE COPPER	 MAX AIR TECHNOLOGY	 LOW DRAG BLADE TECHNOLOGY	 100% QUALITY CHECK	 MULTI-FINISH	 ANTI-RUST



ECONOMY FANS





SWEEP (MM)	POWER INPUT (W)	SPEED (RPM)	AIR DELIVERY (CMM)
1200	75	400	225



MAX AIR
TECHNOLOGY

ETERNA
BIANCO



MAVEN



SWEEP (MM)	POWER INPUT (W)	SPEED (RPM)	AIR DELIVERY (CMM)
1200	70	390	210



MAX AIR
TECHNOLOGY



MAVEN
BROWN



Rosegold



White



Black

CHARISMA

CHARISMA
WHITE GOLD



Rose Silver



Classics Blue Silver



Cool Grey Silver



Carob Brown Silver



Saturn Balck Silver

SWEEP (MM) 1200	POWER INPUT (W) 75	SPEED (RPM) 400	AIR DELIVERY (CMM) 210
---------------------------	------------------------------	---------------------------	----------------------------------

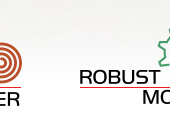

ANTI - RUST



ZOOMER



SWEEP (MM)	POWER INPUT (W)	SPEED (RPM)	AIR DELIVERY (CMM)
1400 / 1200 / 1050 / 900 / 600	75 / 75 / 75 / 70 / 75	290 / 400 / 400 / 440 / 800	250 / 225 / 160 / 150 / 120



HIGH SPEED



DOUBLE BALL BEARING



STAY COOL MOTOR



7 STEP TANK CLEANING & RE-DUSTING



3 STEP PAINT



EXTRA COPPER



MPMV Max Performance Minimum Voltage



HIGH AIR COVERAGE



99.9% PURE COPPER



MAX AIR TECHNOLOGY



LOW DRAG BLADE TECHNOLOGY



100% QUALITY CHECK



MULTI-FINISH



ANTI-RUST

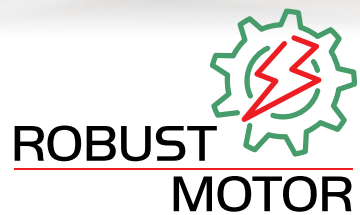

ROBUST MOTOR

ZOOMER
WHITE

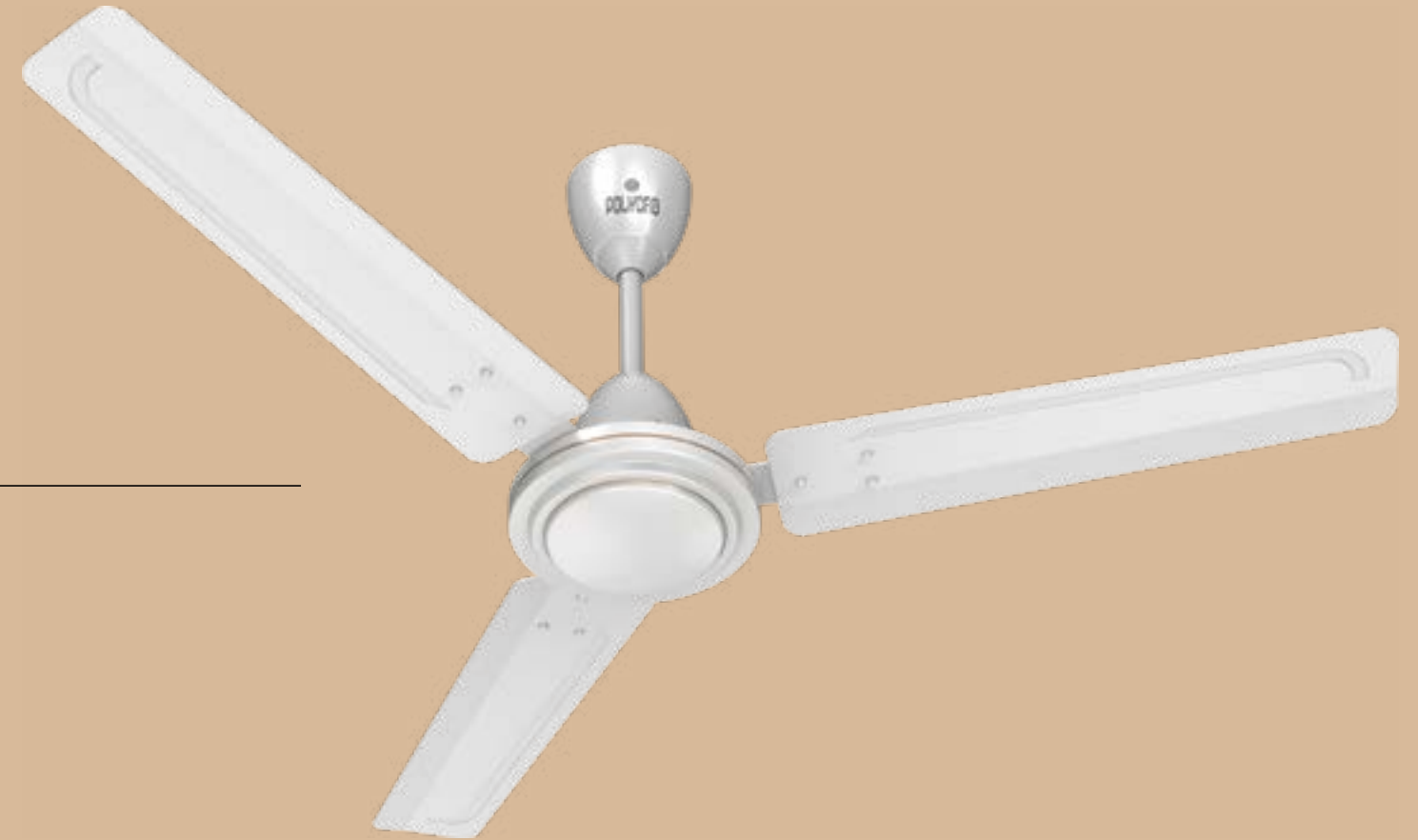

Luster Brown



Bianco

AMAZE HS



SWEEP (MM) 1200	POWER INPUT (W) 75	SPEED (RPM) 400	AIR DELIVERY (CMM) 235
---------------------------	------------------------------	---------------------------	----------------------------------

- DOUBLE BALL BEARING
- STAY COOL MOTOR
- 7 TANK CLEANING & RE-DUSTING
- 3 STEP PAINT
- EXTRA COPPER
- ROBUST MOTOR
- MPMV Max Performance Minimum Voltage
- HIGH AIR COVERAGE
- 99.9% PURE COPPER
- MAX AIR TECHNOLOGY
- LOW DRAG BLADE TECHNOLOGY
- 100% QUALITY CHECK
- MULTI-FINISH
- ANTI-RUST



AMAZE HS
MATT BROWN



AMAZE DLX

AMAZE DLX
BIANCO



Matt Brown



White

SWEEP (MM)	POWER INPUT (W)	SPEED (RPM)	AIR DELIVERY (CMM)
1400 / 1200 / 900 / 600	75 / 75 / 70 / 75	290 / 400 / 440 / 800	250 / 235 / 150 / 120

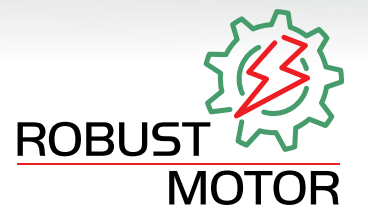

GLORY



SWEEP (MM)	POWER INPUT (W)	SPEED (RPM)	AIR DELIVERY (CMM)
1400 / 1200 / 900	75 / 75 / 90	290 / 400 / 650	250 / 225 / 160



DOUBLE BALL BEARING



STAY COOL MOTOR



7 TANK CLEANING & RE-DUSTING



3 STEP PAINT



EXTRA COPPER



ROBUST MOTOR



MPMV
Max Performance Minimum Voltage



HIGH AIR COVERAGE



99.9% PURE COPPER



MAX AIR TECHNOLOGY



LOW DRAG BLADE TECHNOLOGY



100% QUALITY CHECK



MULTI-FINISH



ANTI-RUST

650 RPM

POLYCARB

GLORY
WHITE

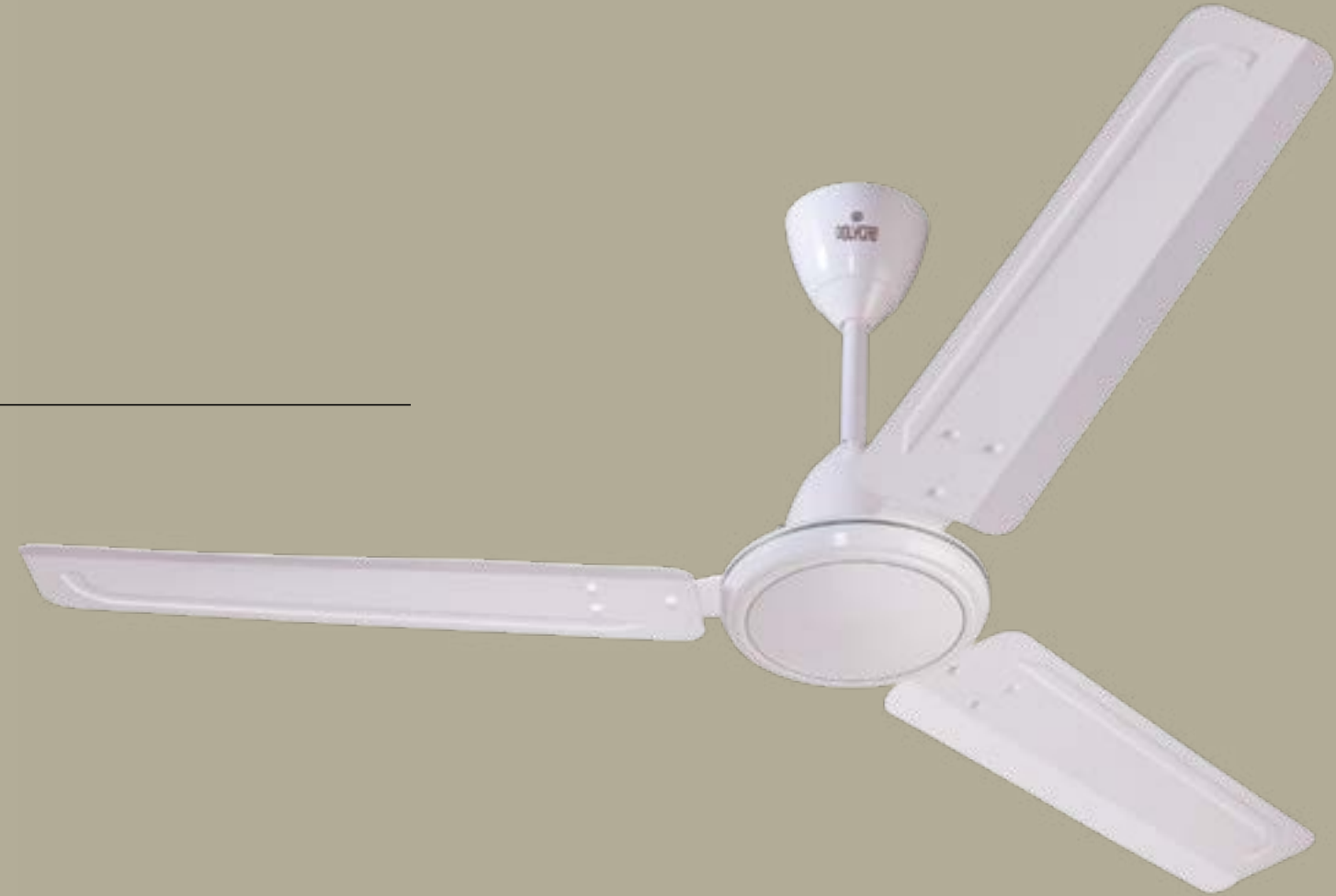

Bianco



Lustre Brown

JUNO

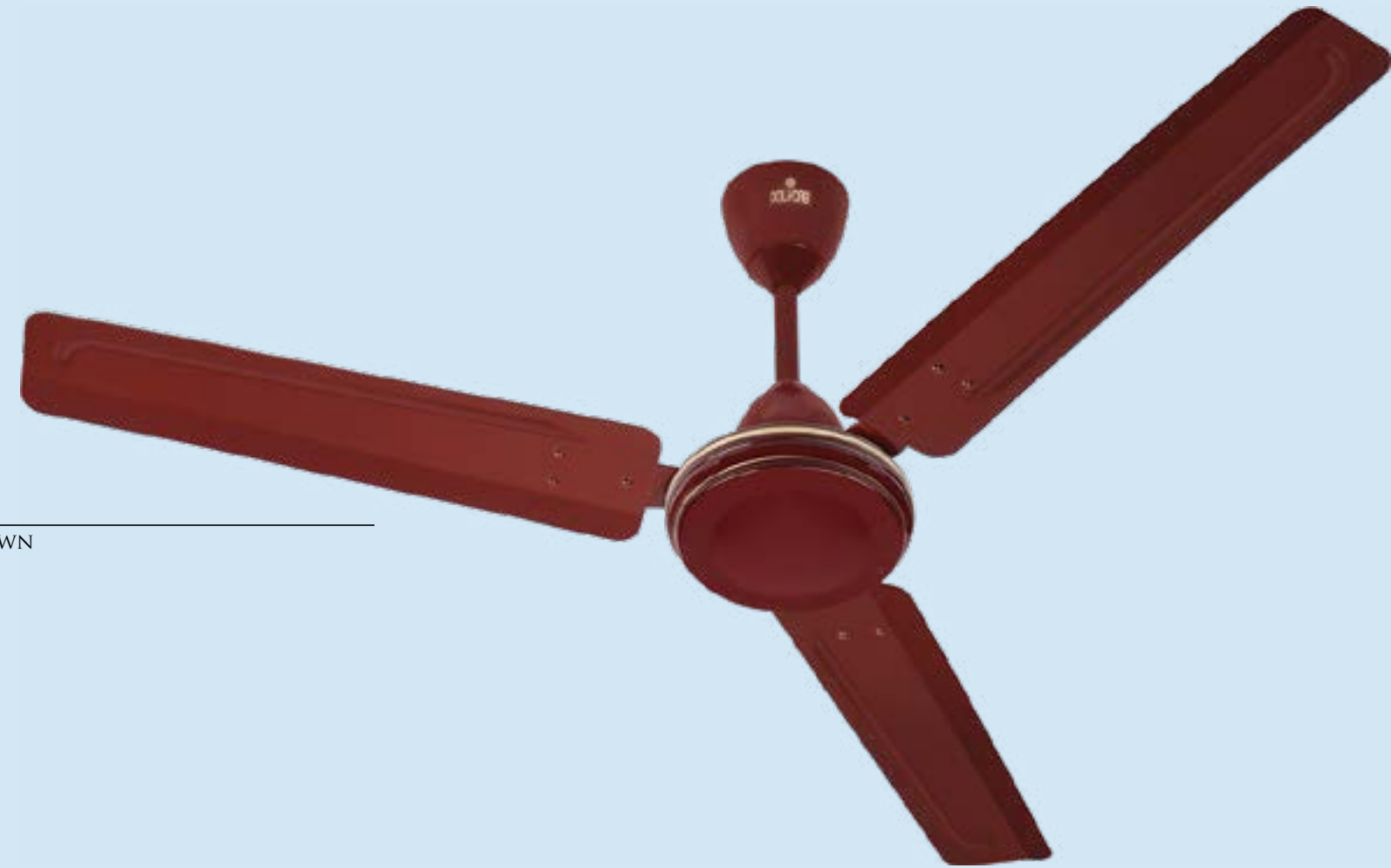

JUNO
LUSTER BROWN



White

Also available in:

 Bianco



SWEEP (MM)	POWER INPUT (W)	SPEED (RPM)	AIR DELIVERY (CMM)
1200	75	400	225



JUNO DLX

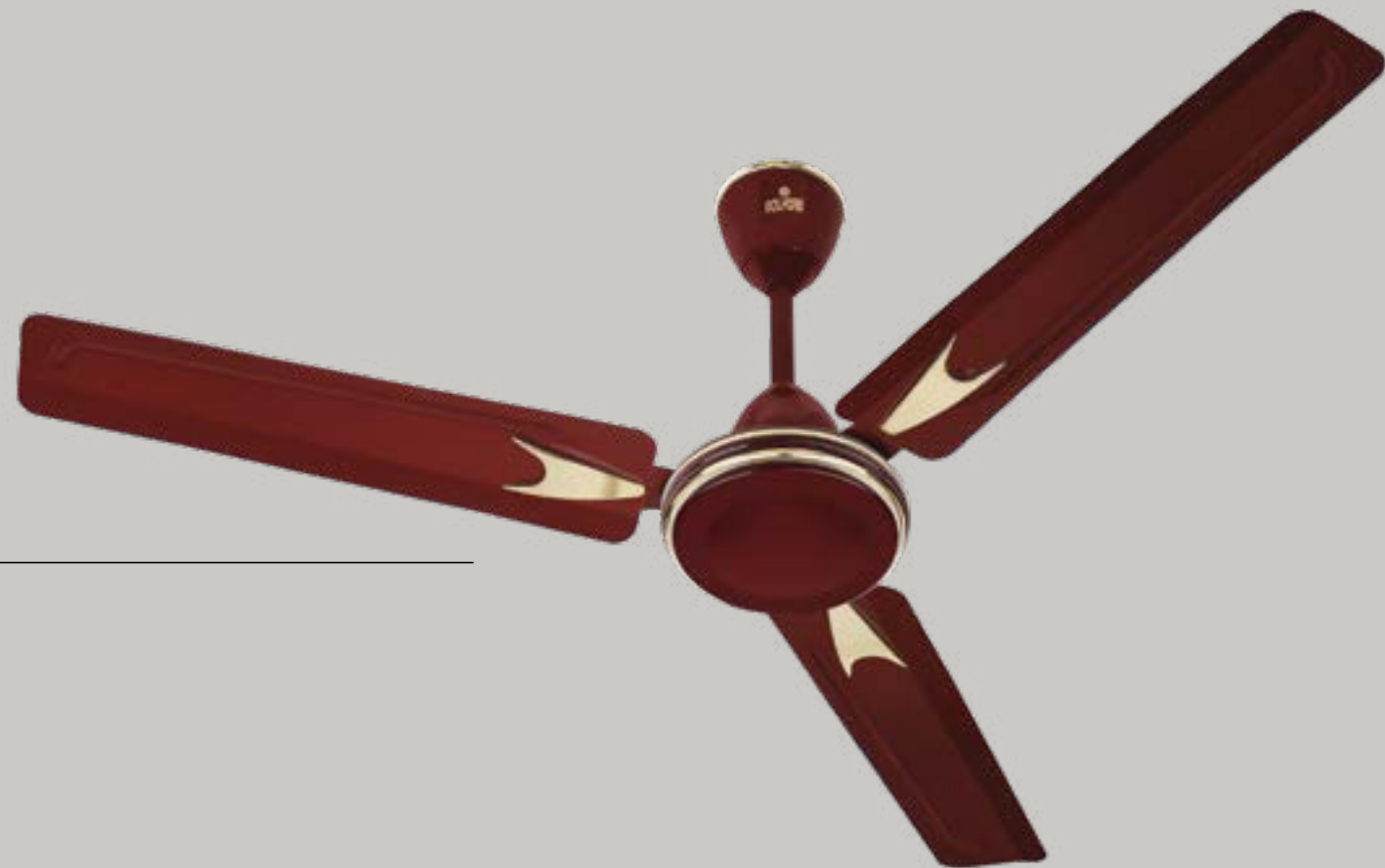

JUNO DLX
LUSTER BROWN

Also available in:
Bianco | White



SWEEP (MM)	POWER INPUT (W)	SPEED (RPM)	AIR DELIVERY (CMM)
1200	75	400	210



ZOOMER DLX

ZOOMER DLX
WHITE



Bianco



Luster Brown

SWEEP (MM)	POWER INPUT (W)	SPEED (RPM)	AIR DELIVERY (CMM)
1400 / 1200 / 1050 / 900 / 600	75 / 75 / 75 / 70 / 75	290 / 400 / 400 / 440 / 800	250 / 225 / 160 / 150 / 120



HIGH SPEED



DOUBLE BALL BEARING



STAY COOL MOTOR



7 TANK CLEANING & RE-DUSTING



3 STEP PAINT



EXTRA COPPER



ROBUST MOTOR



MPMV
Max Performance Minimum Voltage



HIGH AIR COVERAGE



99.9% PURE COPPER



MAX AIR TECHNOLOGY



100% QUALITY CHECK



MULTI-FINISH



ANTI-RUST

LOW DRAG BLADE TECHNOLOGY



SYLPHY



SWEEP (MM) 1200 / 1050 / 900	POWER INPUT (W) 75 / 75 / 70	SPEED (RPM) 400 / 400 / 440	AIR DELIVERY (CMM) 225 / 160 / 150
--	--	---------------------------------------	--

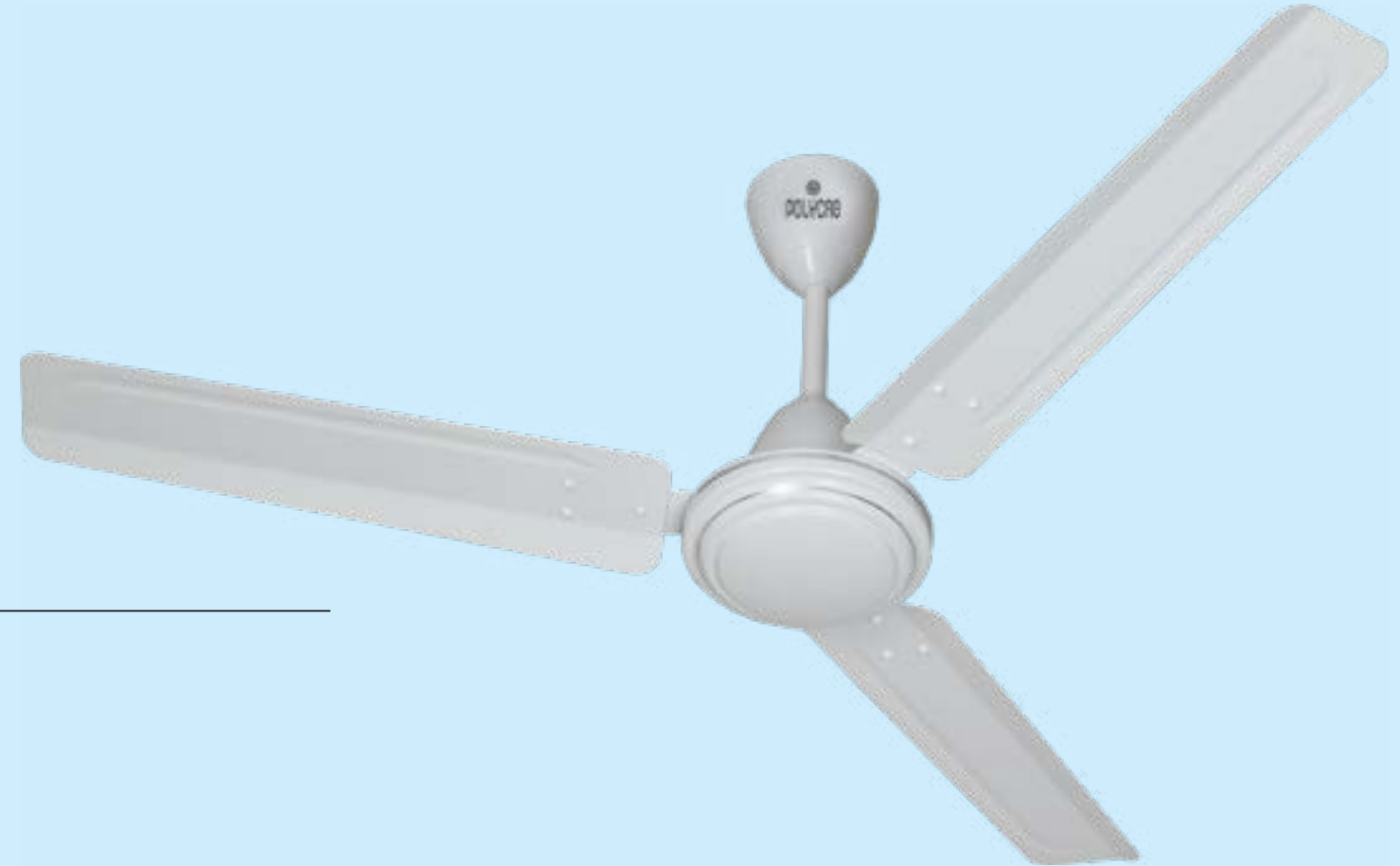

SYLPHY
WHITE



Also available in:

Bianco

Luster Brown

SYLPHY DLX

SYLPHY DLX
WHITE PEARL BLUE

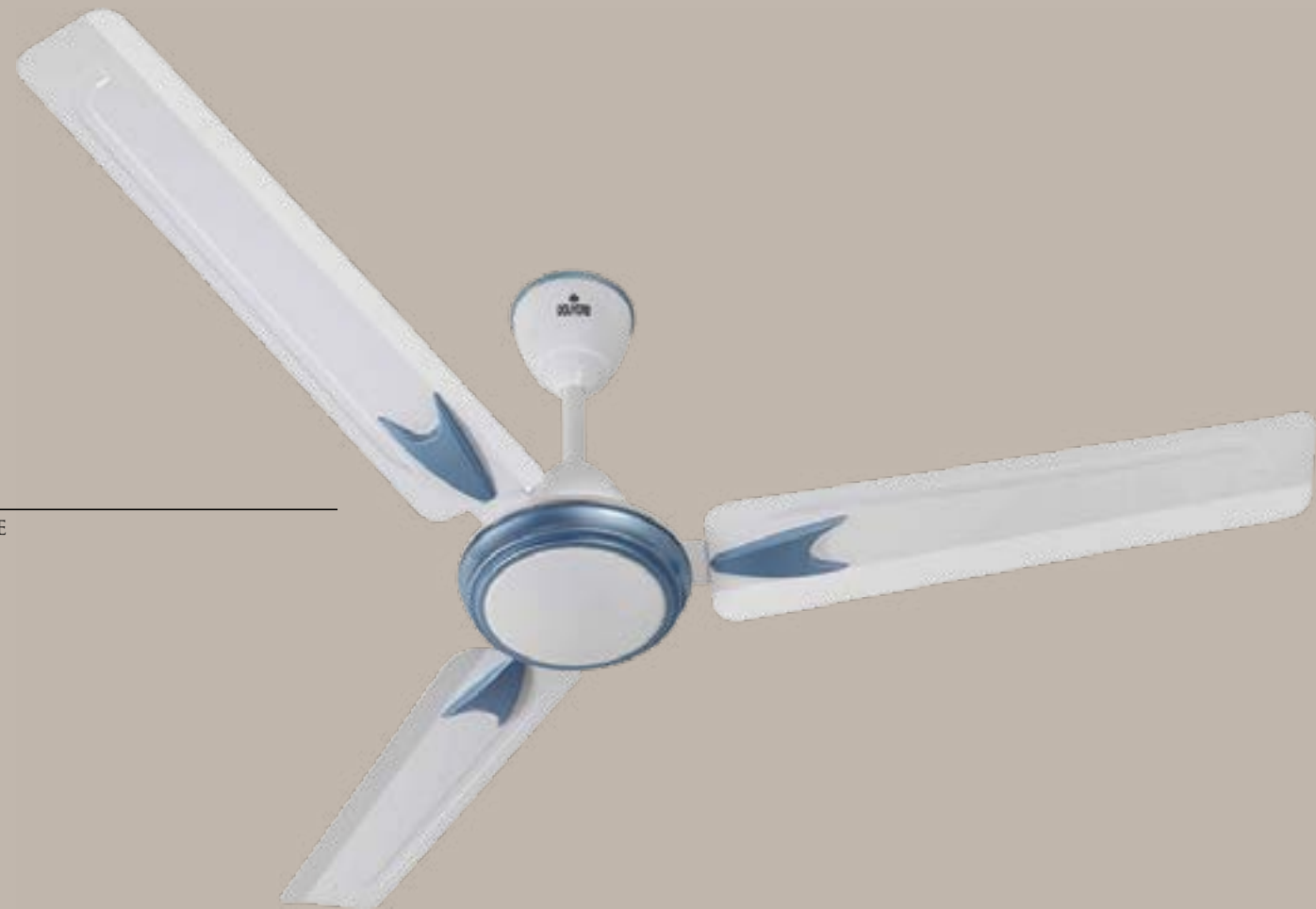

Bianco Pearl Woodland



Luster Brown HD Beige



SWEEP (MM)	POWER INPUT (W)	SPEED (RPM)	AIR DELIVERY (CMM)
1200 / 1050 / 900	75 / 75 / 70	400 / 400 / 440	225 / 160 / 150



DOUBLE BALL BEARING



STAY COOL MOTOR



7 TANK CLEANING & RE-DUSTING



3 STEP PAINT



EXTRA COPPER



ROBUST MOTOR



MPMV
Max Performance Minimum Voltage



HIGH AIR COVERAGE



99.9% PURE COPPER



MAX AIR TECHNOLOGY



LOW DRAG BLADE TECHNOLOGY



100% QUALITY CHECK



MULTI-FINISH



ANTI-RUST



ANNULAR



SWEEP (MM)	POWER INPUT (W)	SPEED (RPM)	AIR DELIVERY (CMM)
1200 / 1050 / 900	75 / 75 / 70	400 / 400 / 440	225 / 160 / 150



HIGH SPEED



DOUBLE BALL BEARING



STAY COOL MOTOR



7 TANK CLEANING & RE-DUSTING



3 STEP PAINT



EXTRA COPPER



ROBUST MOTOR



MPMV
Max Performance Minimum Voltage



99.9% PURE COPPER



MAX AIR TECHNOLOGY



LOW DRAG BLADE TECHNOLOGY



100% QUALITY CHECK



MULTI-FINISH



ANTI-RUST

HIGH AIR COVERAGE

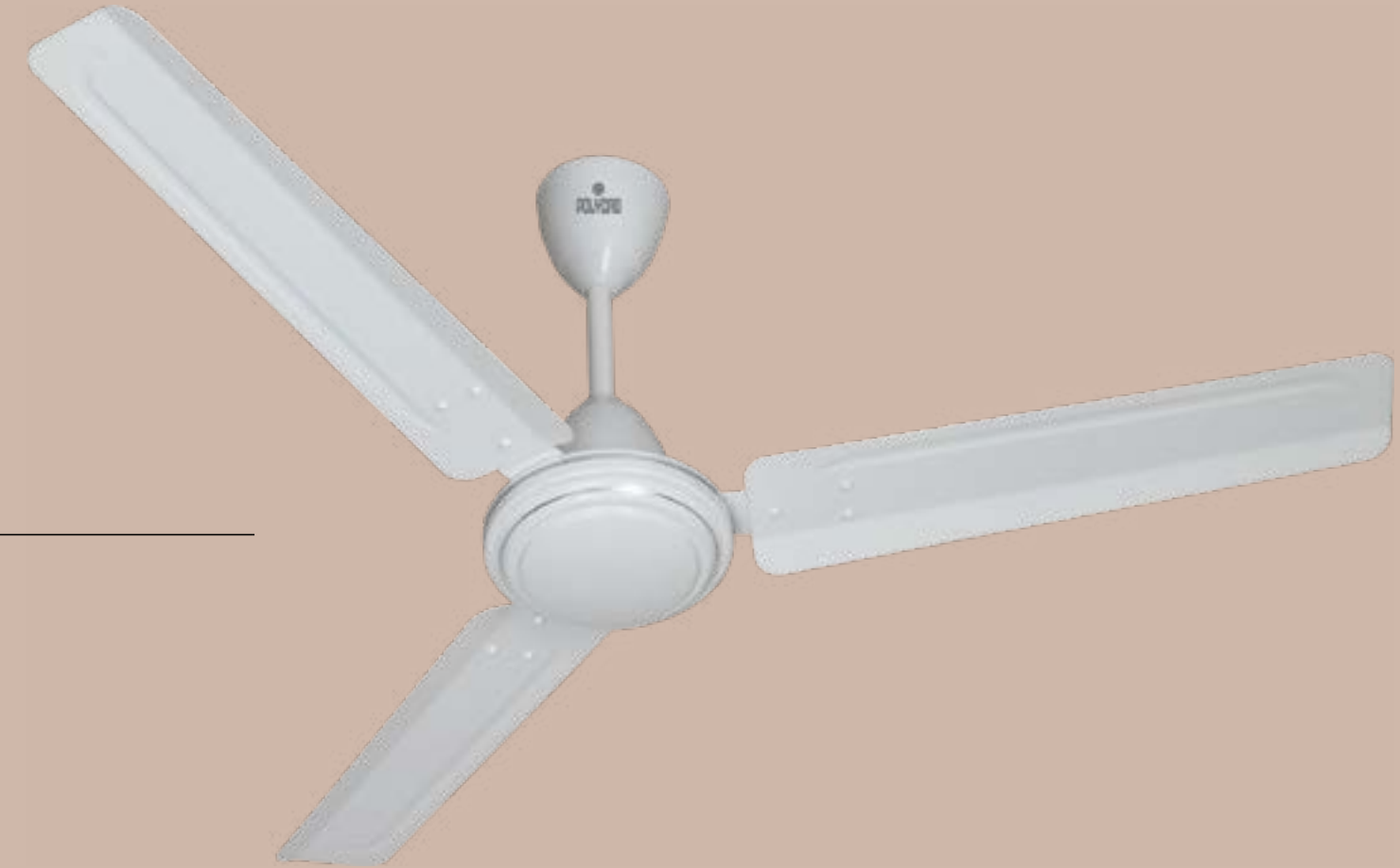
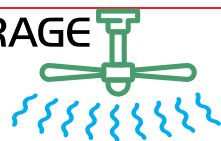

ANNULAR
WHITE

Also available in:

Bianco



Luster Brown

ANNULAR DLX



ANNULAR DLX
WHITE PEARL GREY



SWEEP (MM)	POWER INPUT (W)	SPEED (RPM)	AIR DELIVERY (CMM)
1200 / 1050 / 900	75 / 75 / 70	400 / 400 / 440	225 / 160 / 150



Bianco Honey Gold



Luster Brown Copper Bronze

Also available in:
Bianco Wine Red

- DOUBLE BALL BEARING
- STAY COOL MOTOR
- 7 TANK CLEANING & RE-DUSTING
- 3 STEP PAINT
- EXTRA COPPER
- ROBUST MOTOR
- MPMV Max Performance Minimum Voltage
- HIGH AIR COVERAGE
- 99.9% PURE COPPER
- MAX AIR TECHNOLOGY
- LOW DRAG BLADE TECHNOLOGY
- 100% QUALITY CHECK
- MULTI-FINISH
- ANTI-RUST



VIVA



SWEEP (MM) 1200 / 1050 / 900	POWER INPUT (W) 75 / 75 / 70	SPEED (RPM) 400 / 400 / 440	AIR DELIVERY (CMM) 225 / 160 / 150
--	--	---------------------------------------	--



STAY COOL MOTOR

POLYCOB

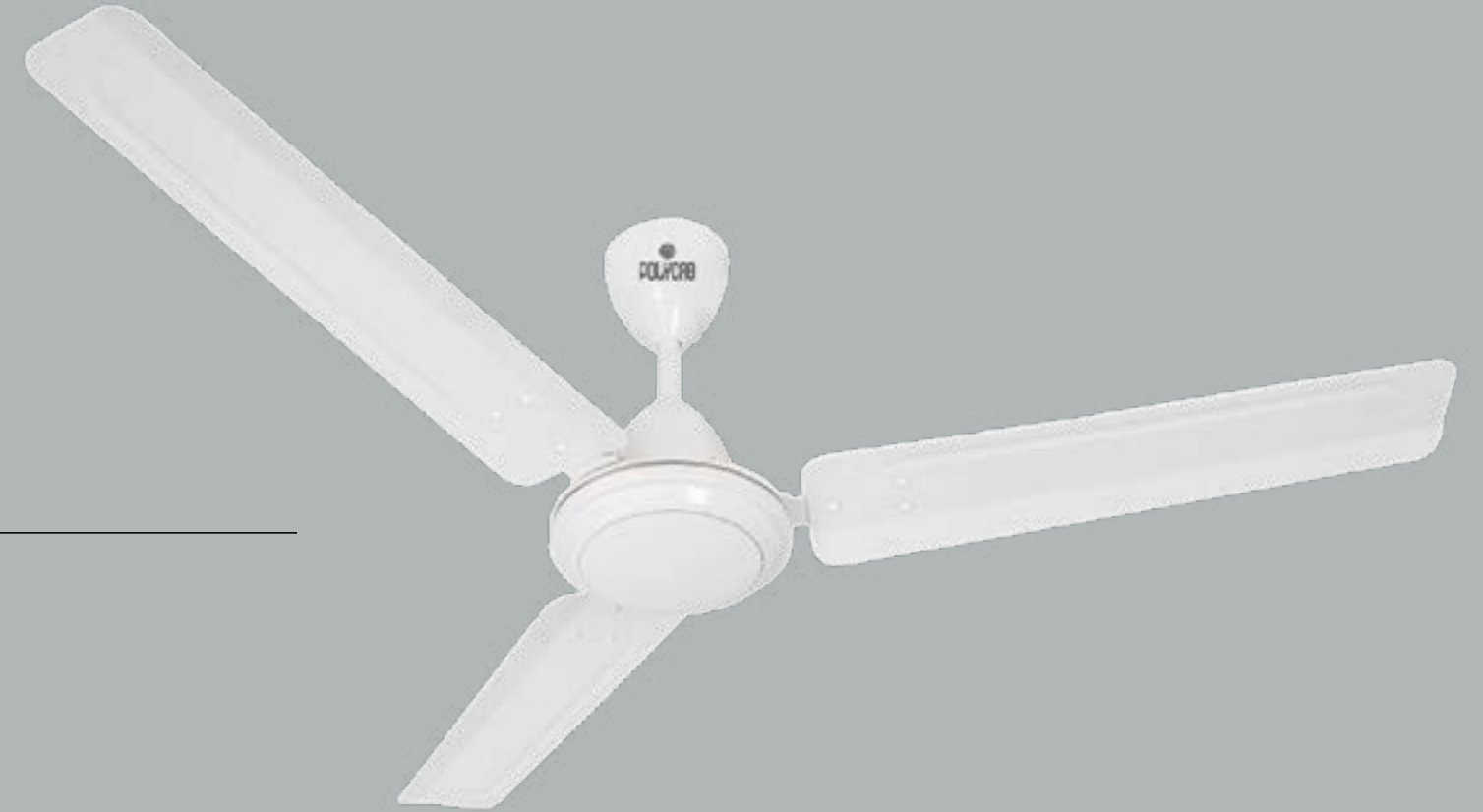

VIVA
WHITE



Bianco



Luster Brown

VIVA DLX

VIVA DLX
WHITE



Bianco



Luster Brown



SWEEP (MM)	POWER INPUT (W)	SPEED (RPM)	AIR DELIVERY (CMM)
1200 / 1050 / 900	75 / 75 / 70	400 / 400 / 440	225 / 160 / 150

- DOUBLE BALL BEARING
- STAY COOL MOTOR
- 7 TANK CLEANING & RE-DUSTING
- 3 STEP PAINT
- EXTRA COPPER
- ROBUST MOTOR
- MPMV Max Performance Minimum Voltage
- HIGH AIR COVERAGE
- 99.9% PURE COPPER
- MAX AIR TECHNOLOGY
- LOW DRAG BLADE TECHNOLOGY
- 100% QUALITY CHECK
- MULTI-FINISH
- ANTI-RUST



REVIVO

REVIVO
BROWN



Bianco



White

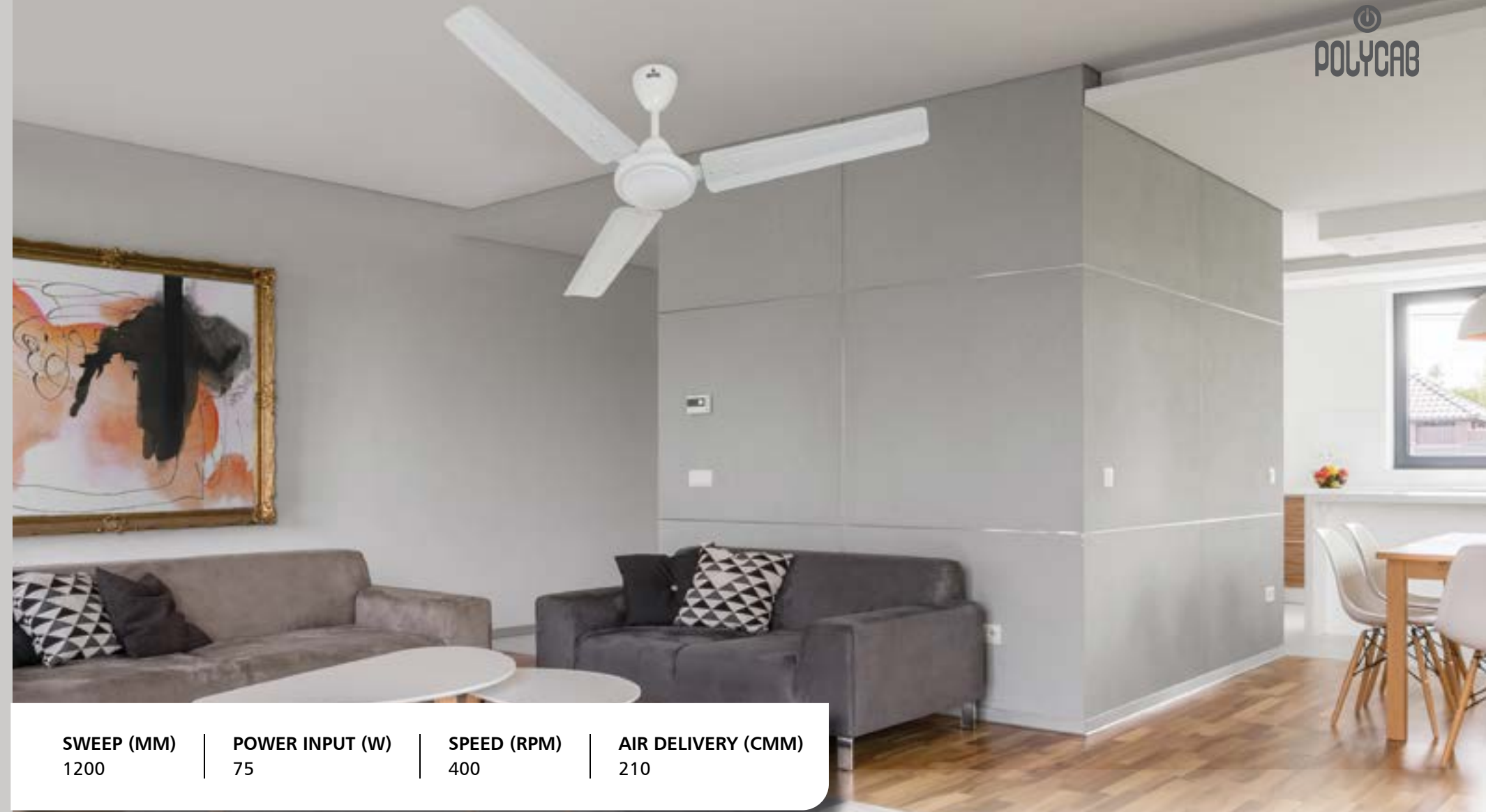

SWEEP (MM)	POWER INPUT (W)	SPEED (RPM)	AIR DELIVERY (CMM)
1200	75	400	210



HIGH AIR COVERAGE



99.9% PURE COPPER



MAX AIR TECHNOLOGY



LOW DRAG BLADE TECHNOLOGY



100% QUALITY CHECK



MULTI-FINISH



ANTI-RUST



ANTI-RUST



TABLE FANS



KEY FEATURES-TPW FANS



Polycab TPW fans are meticulously engineered to prevent overheating of motor and blades, thus increasing its efficiency.



A high-performance motor powers Polycab TPW fans, thus ensuring greater comfort & excellent air circulation throughout the room.

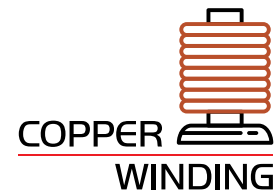

The low resistivity of copper reduces energy losses and also increases the lifespan of the fan motor.



The aerodynamically designed blades coupled with increased blade width reduce drag and maximizes air delivery.

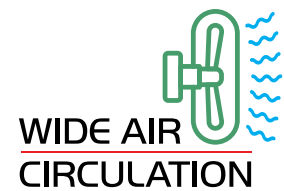

Polycab TPW fans give you the highest air delivery and wide air throw to cool the room.



Jerk free and uniform oscillation ensures the flow of cool air reaches all the parts of a room with ease.



A protection tool that prevents small children from inserting their finger or accidentally touching the fast rotating blades.



The adjustable height setting allows users to adjust the height as per their requirement.



A high-performing electric motor that operates at optimum efficiency yet consumes much less power.



Polycab TPW fans have aerodynamically balanced blades for superior air delivery.



Polycab TPW fans are fitted with a high performance, totally enclosed motor that delivers maximum output.



The exhaust fan helps extract stale, impure air, along with moisture and dirt, and encourages continuous circulation of fresh air, thereby improving the air quality.



The specially designed blades suck out smoke, fine dust particles, odour and fume, thus leaving a fresh and pleasant environment in your bathroom and kitchen.



Polycab Exhaust fans come with a high-performance, efficient motor that provides excellent air throw.



The blades rotate at the speed of 2000 RPM which makes Polycab Exhaust fans very effective at drawing out stale air and fumes quickly from any room.

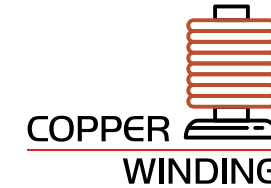

The low resistivity of copper reduces energy losses and also increases the lifespan of the fan motor.



The simple design and efficient functionality of Polycab Exhaust fans makes it easy to clean and maintain.



A highly specialized coating that prevents rusting and provides robust protection against corrosion.

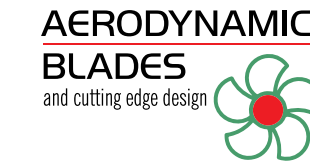

The aerodynamically designed blades coupled with increased blade width reduce drag and maximizes the air sweep.



The contoured blade design ensures a vibration free and noiseless operation at all times. Now you can work or sleep without any disturbance.



Polycab Exhaust fans are fitted with a high performance, totally enclosed motor that delivers maximum output – working continuously for hours - at lower operating cost.



Powder coated finish increases the lifespan of the exhaust fan and also blends well with any interior.



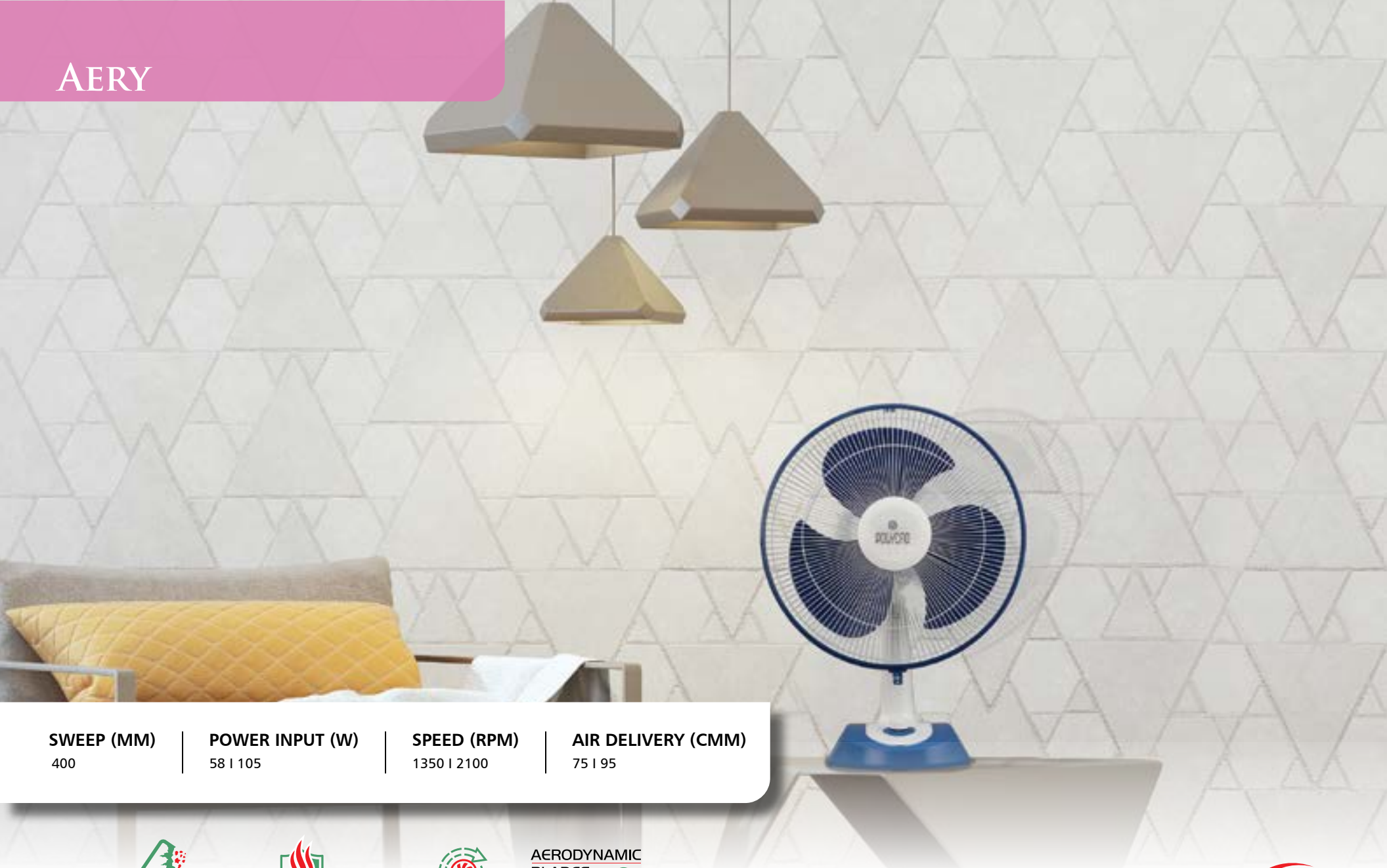

SWEEP (MM)	POWER INPUT (W)	SPEED (RPM)	AIR DELIVERY (CMM)
400	58 105	1350 2100	75 95

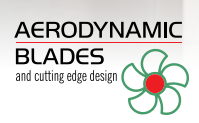

HIGH AIR THRUST

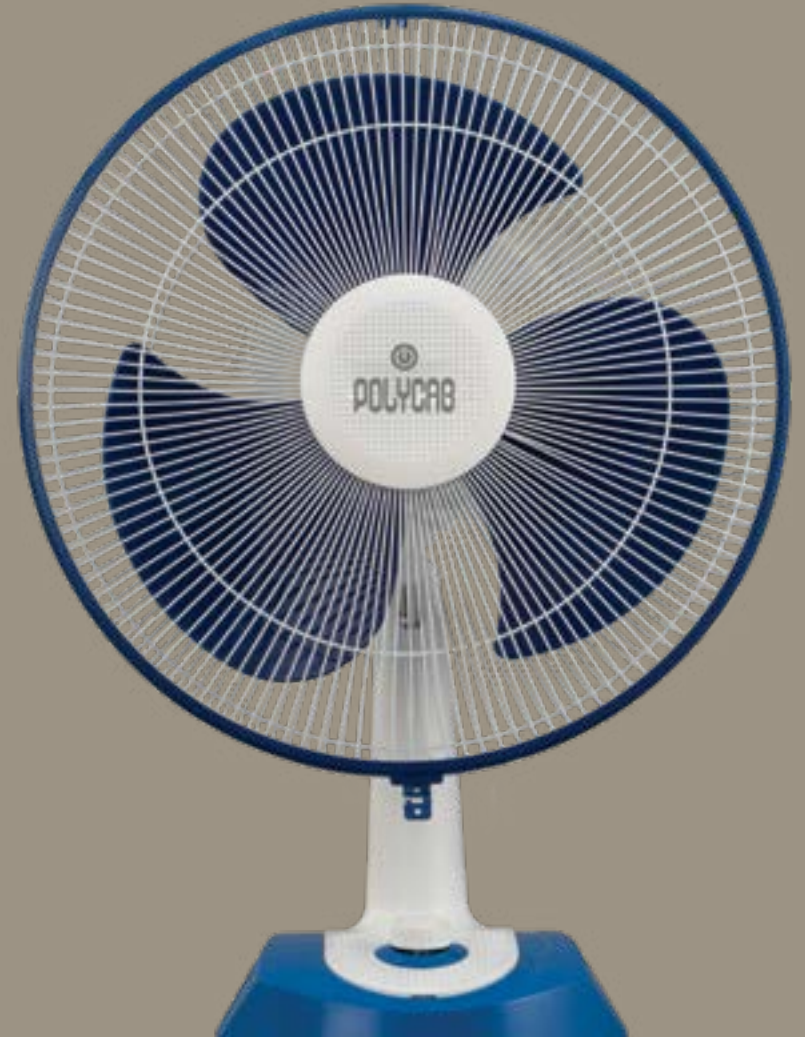

THUNDER STORM



SWEEP (MM) 400	POWER INPUT (W) 125	SPEED (RPM) 2000	AIR DELIVERY (CMM) 90
--------------------------	-------------------------------	----------------------------	---------------------------------

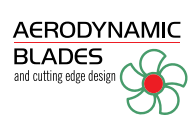

CHILD SAFETY GUARD

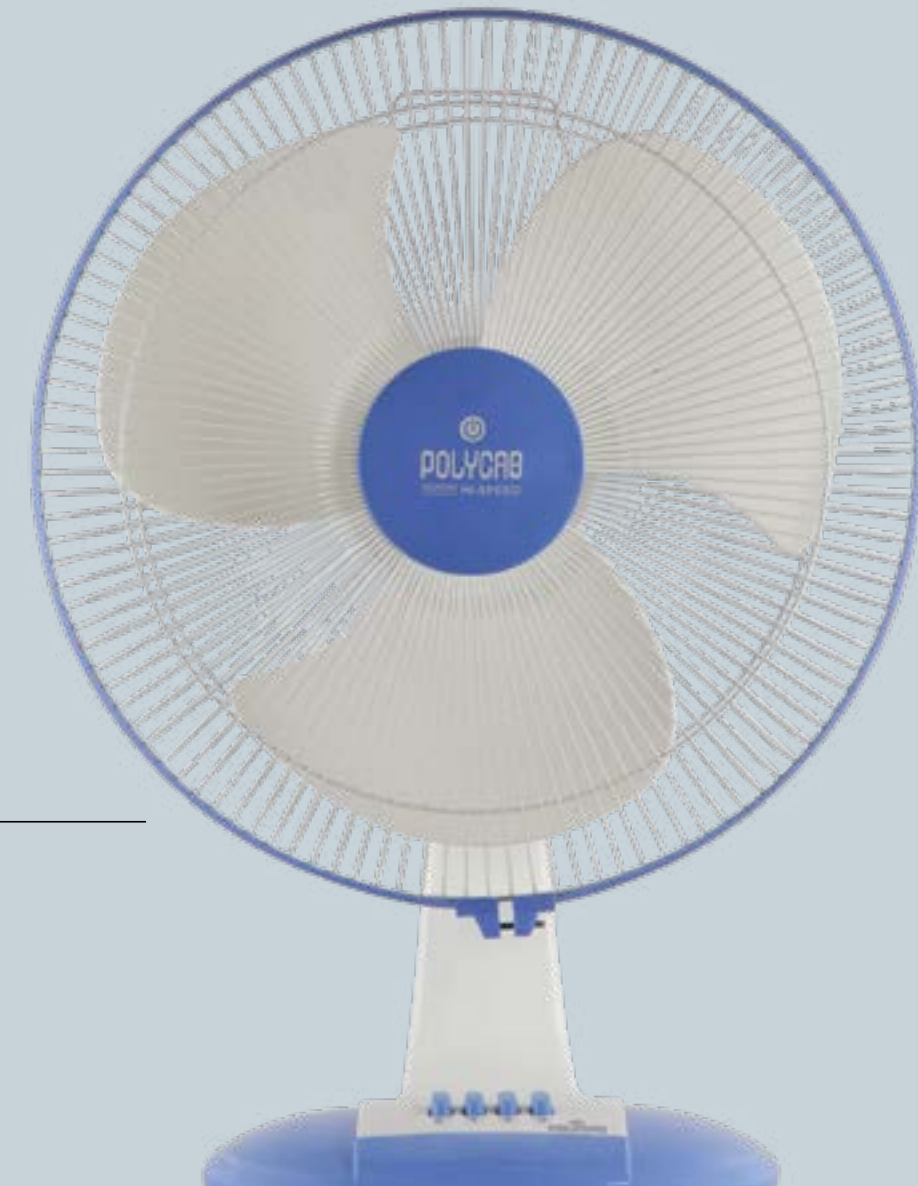

WHITE BLUE

Also available in:



WHITE

UNICORN

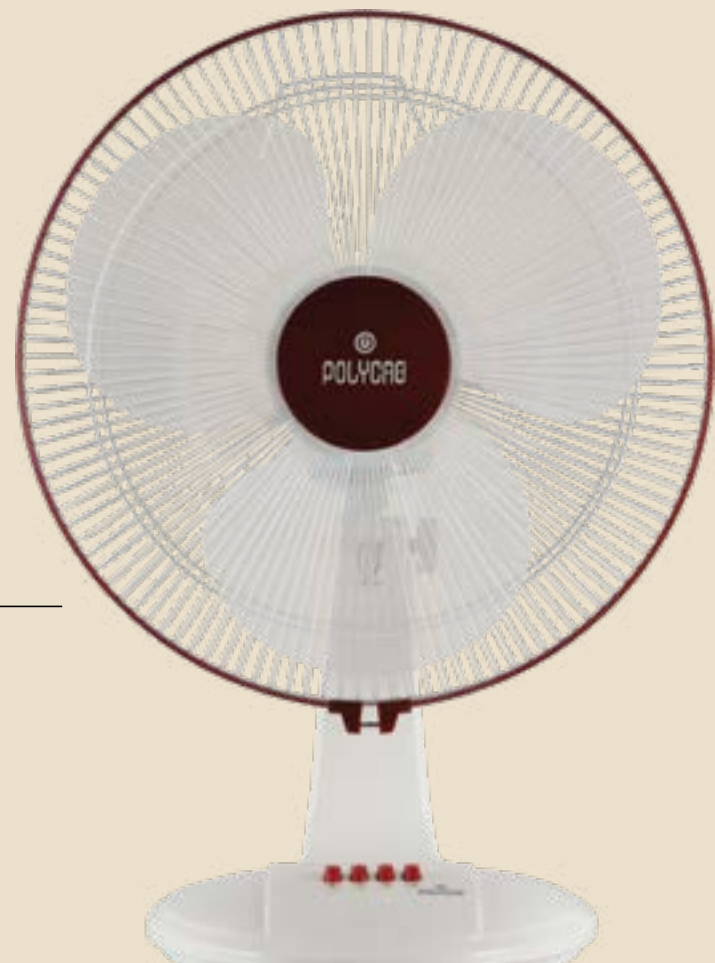

WHITE MAROON

Also available in:

WHITE



SWEEP (MM) 400	POWER INPUT (W) 55	SPEED (RPM) 1350	AIR DELIVERY (CMM) 70
--------------------------	------------------------------	----------------------------	---------------------------------

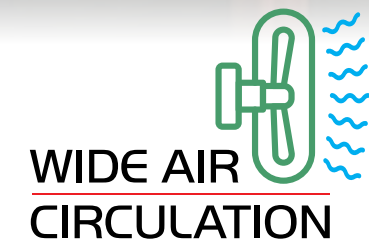
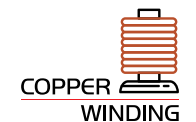



SWEEP (MM)	POWER INPUT (W)	SPEED (RPM)	AIR DELIVERY (CMM)
400	50	1350	65

ANTI-RUST COATING

HEAT GUARD
Thermal Overload Protector

HIGH AIR THRUST

HEAVY DUTY MOTOR

COPPER WINDING

OPMP
Optimal Performance Minimal Power

SMOOTH OSCILLATION

AERODYNAMIC BLADES
and cutting edge design



WIDE AIR CIRCULATION

WHITE GREY

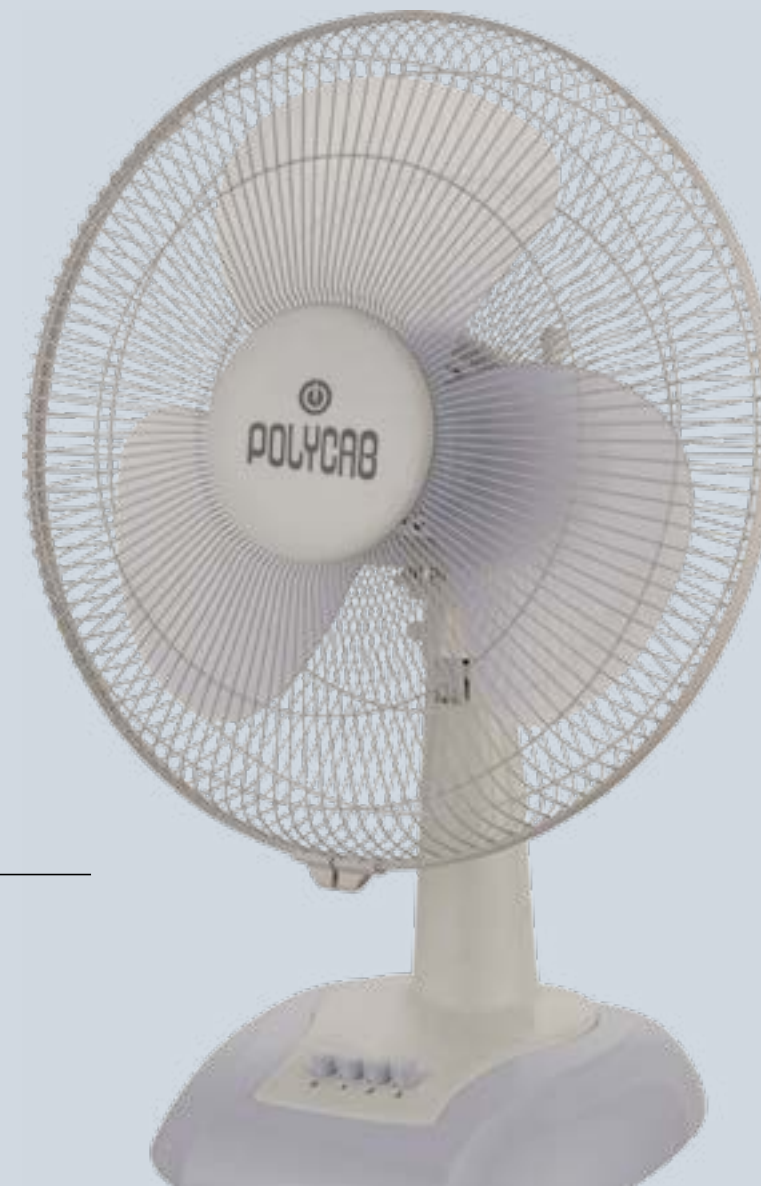



DARK BLUE



Green



Brown

SWEEP (MM) 400	POWER INPUT (W) 60	SPEED (RPM) 1320	AIR DELIVERY (CMM) 80
--------------------------	------------------------------	----------------------------	---------------------------------



ELANZA PT01

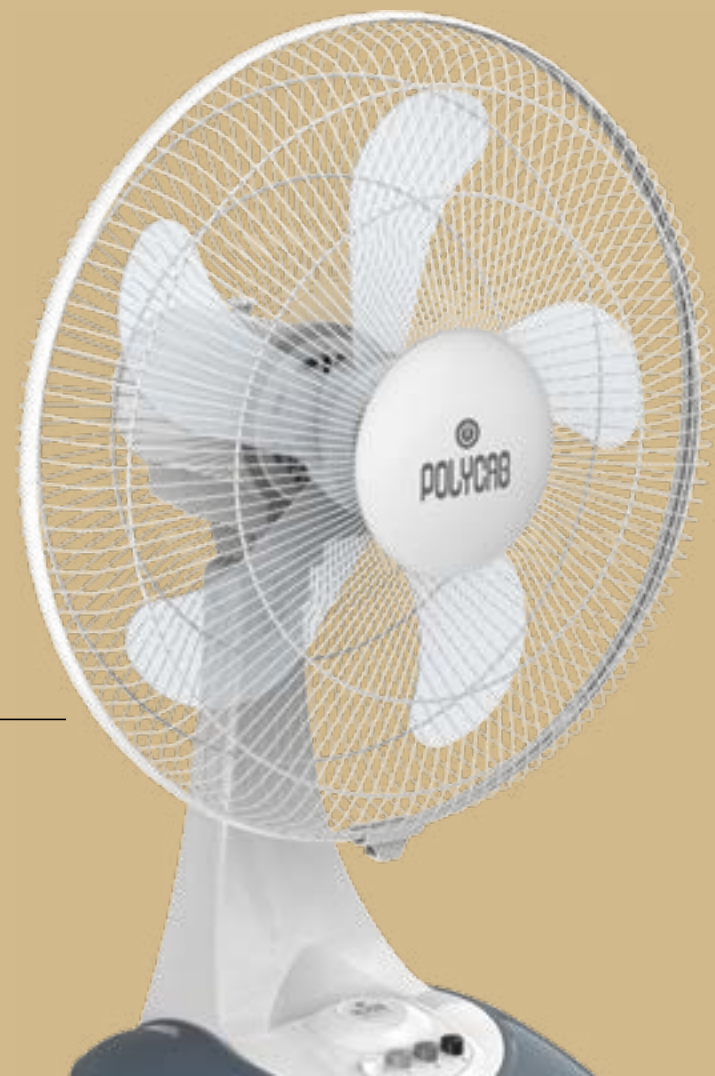

WHITE GREY



SWEEP (MM)	POWER INPUT (W)	SPEED (RPM)	AIR DELIVERY (CMM)
400	60	1330	70



PEDESTAL FANS





WHITE BLUE



SWEEP (MM)	POWER INPUT (W)	SPEED (RPM)	AIR DELIVERY (CMM)
400	58 105	1350 2100	75 95



THUNDERSTORM



WHITE GREY

SWEEP (MM)	POWER INPUT (W)	SPEED (RPM)	AIR DELIVERY (CMM)
400	125	2000	90

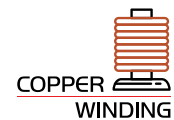

WHITE BLUE



Also available in:

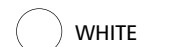

WHITE

UNICORN



WHITE MAROON

Also available in:

WHITE



SWEEP (MM) 400	POWER INPUT (W) 55	SPEED (RPM) 1350	AIR DELIVERY (CMM) 70
--------------------------	------------------------------	----------------------------	---------------------------------





SWEEP (MM)	POWER INPUT (W)	SPEED (RPM)	AIR DELIVERY (CMM)
400	50	1350	65



ANTI-RUST
COATING



HEAT GUARD
Thermal Overload Protector



HIGH AIR
THRUST



HEAVY
DUTY MOTOR



AERODYNAMIC
BLADES
and cutting edge design



COPPER
WINDING



OPMP
Optimal Performance Minimal Power



SMOOTH
OSCILLATION

WIDE AIR
CIRCULATION



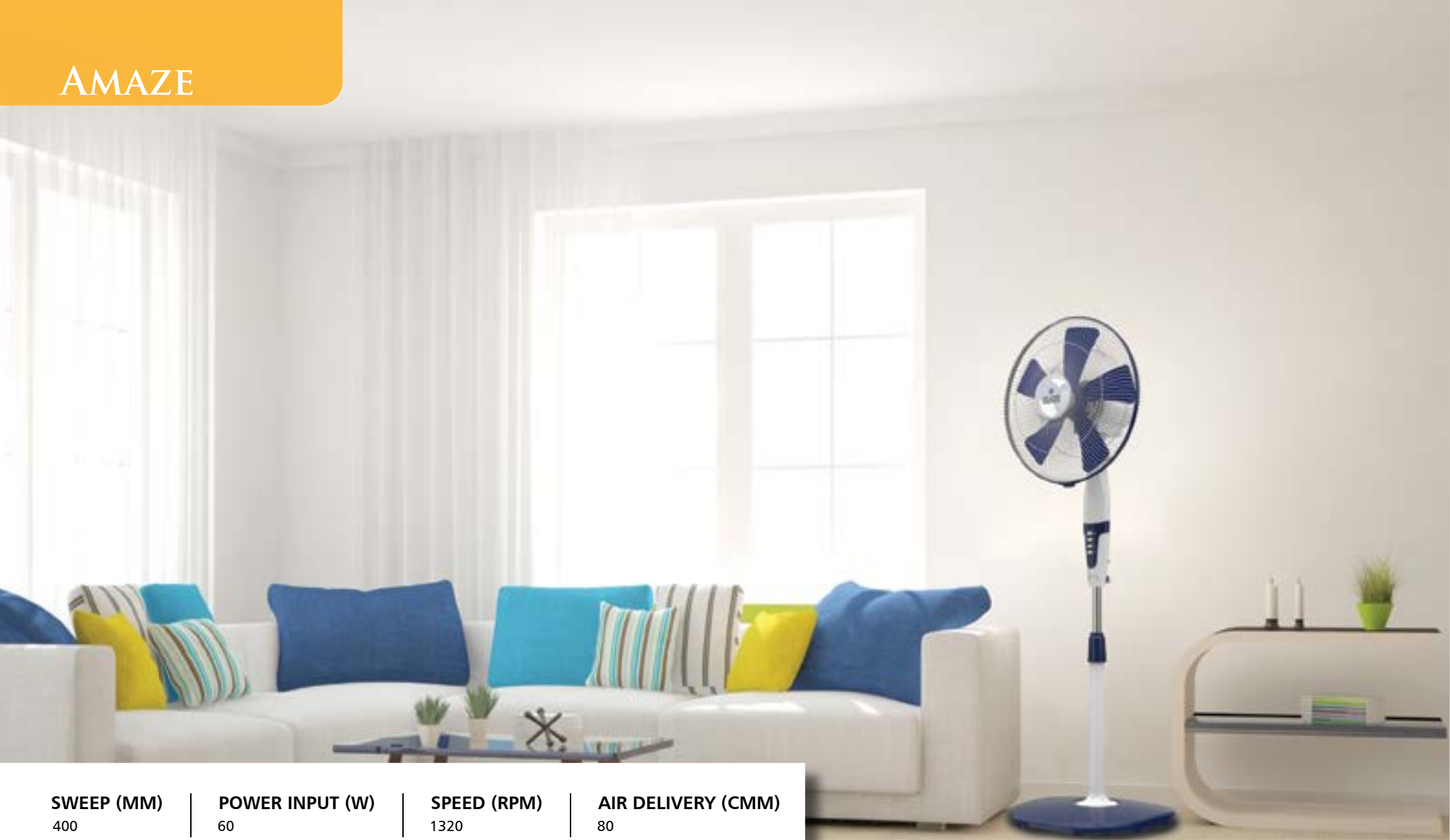

SWEEP (MM)	POWER INPUT (W)	SPEED (RPM)	AIR DELIVERY (CMM)
400	60	1320	80

- ANTI-RUST COATING**
- HEAT GUARD**
Thermal Overload Protector
- HIGH AIR THRUST**
- HEAVY DUTY MOTOR**
- AERODYNAMIC BLADES**
and cutting edge design
- COPPER WINDING**
- OPMP**
Optimal Performance Minimal Power
- SMOOTH OSCILLATION**

WIDE AIR CIRCULATION

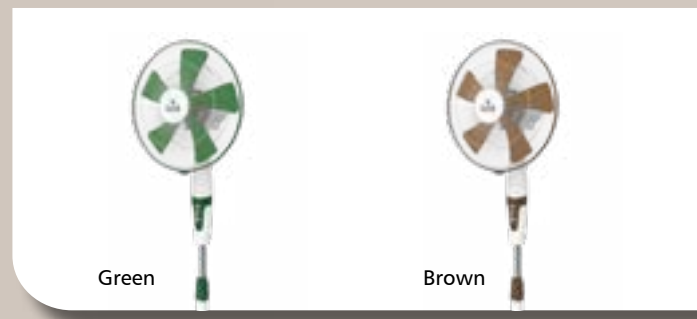



WHITE BLUE

SWEEP (MM)	POWER INPUT (W)	SPEED (RPM)	AIR DELIVERY (CMM)
400	70	1350	85



ELANZA PP01



WHITE GREY

SWEEP (MM)	POWER INPUT (W)	SPEED (RPM)	AIR DELIVERY (CMM)
400	60	1330	70



ELANZA MINI



BLACK



WHITE

SWEEP (MM)	POWER INPUT (W)	SPEED (RPM)	AIR DELIVERY (CMM)
400	47	1300	60

- ANTI-RUST COATING**
- HEAT GUARD**
Thermal Overload Protector
- HIGH AIR THRUST**
- HEAVY DUTY MOTOR**
- COPPER WINDING**
- OPMP**
Optimal Performance Minimal Power
- WIDE AIR CIRCULATION**
- AERODYNAMIC BLADES**
and cutting edge design

SMOOTH OSCILLATION

WALL FANS



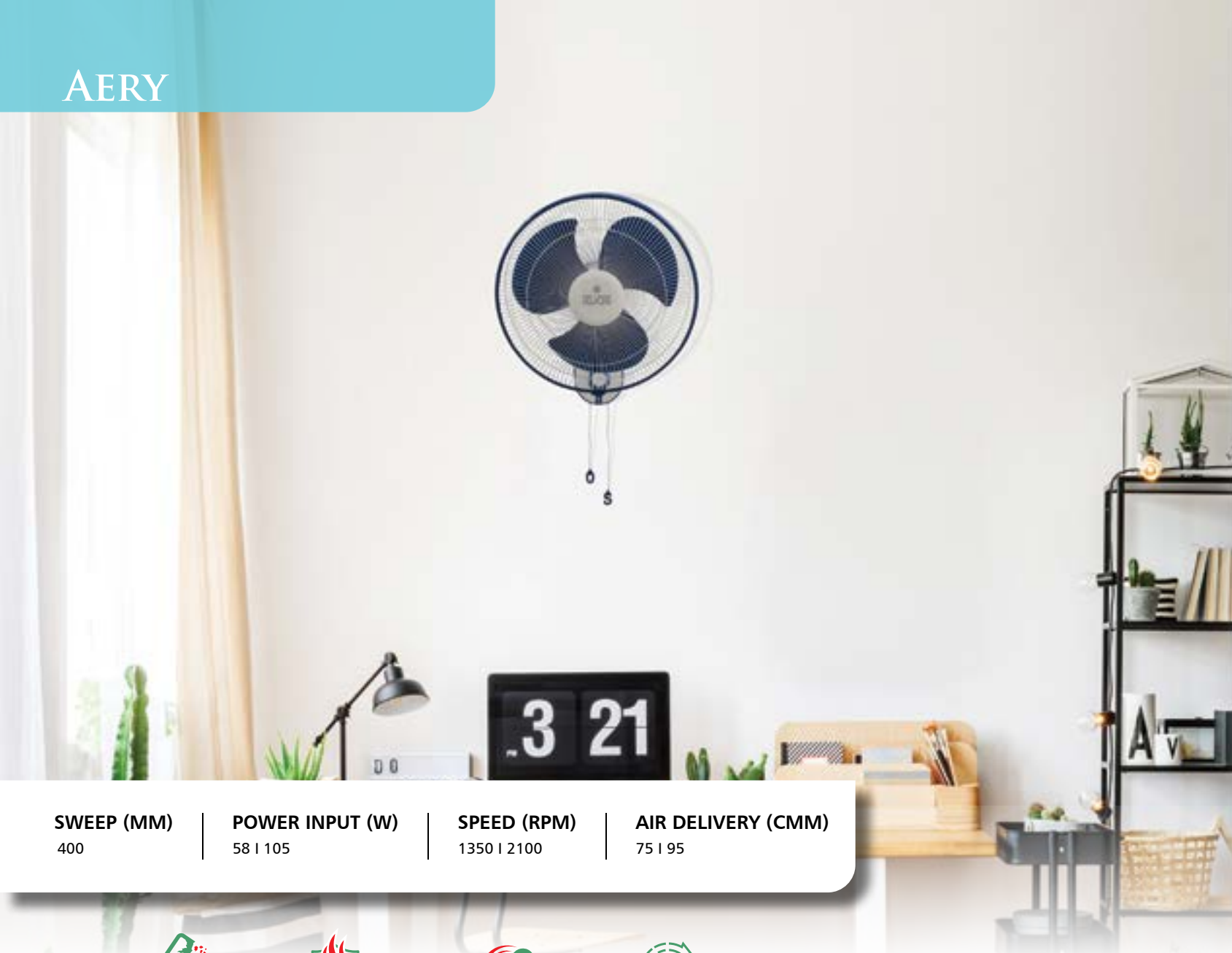

SWEEP (MM)	POWER INPUT (W)	SPEED (RPM)	AIR DELIVERY (CMM)
400	58 105	1350 2100	75 95

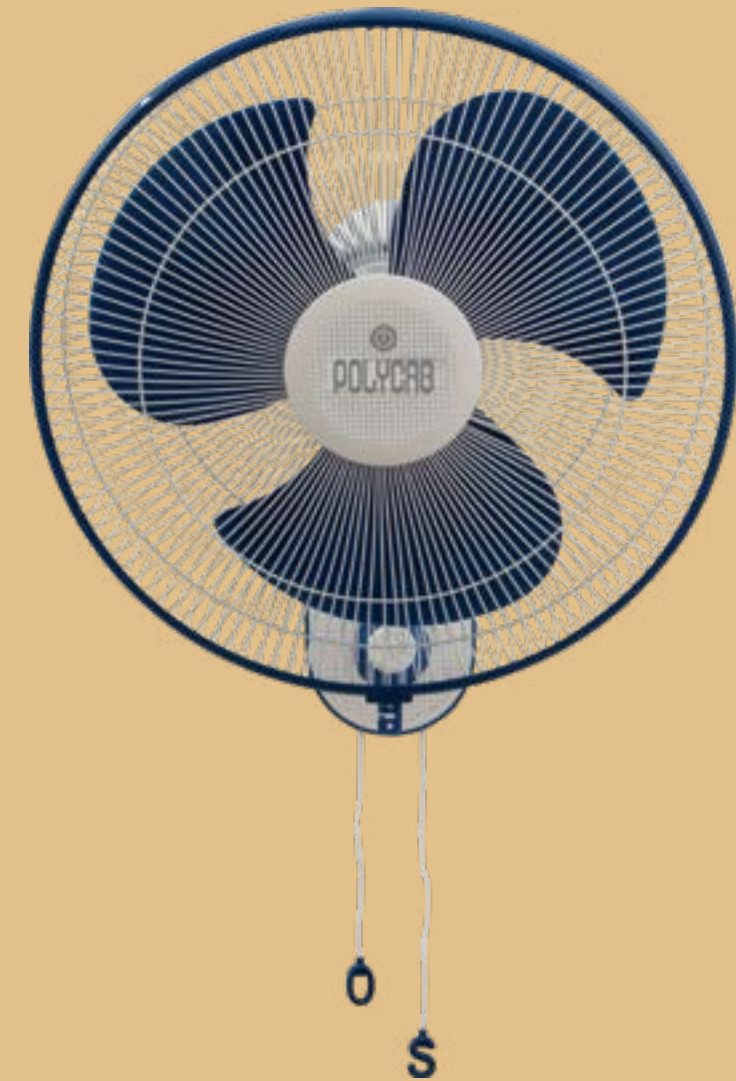
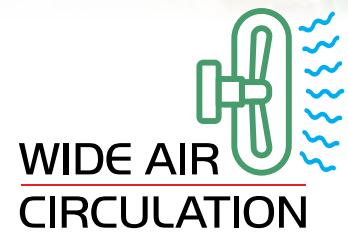
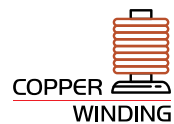

WHITE BLUE

THUNDER STORM



WHITE BLUE

SWEEP (MM)	POWER INPUT (W)	SPEED (RPM)	AIR DELIVERY (CMM)
400 300	125 75	2000 2000	90 60



ANTI-RUST
COATING



HEAT
GUARD
Thermal Overload Protector



HIGH AIR
THRUST



HEAVY
DUTY MOTOR

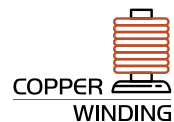

COPPER
WINDING



OPMP
Optimal Performance Minimal Power



SMOOTH
OSCILLATION



WIDE AIR
CIRCULATION

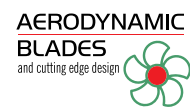

AERODYNAMIC
BLADES
and cutting edge design



WHITE GREY

Also available in:
 WHITE

UNICORN

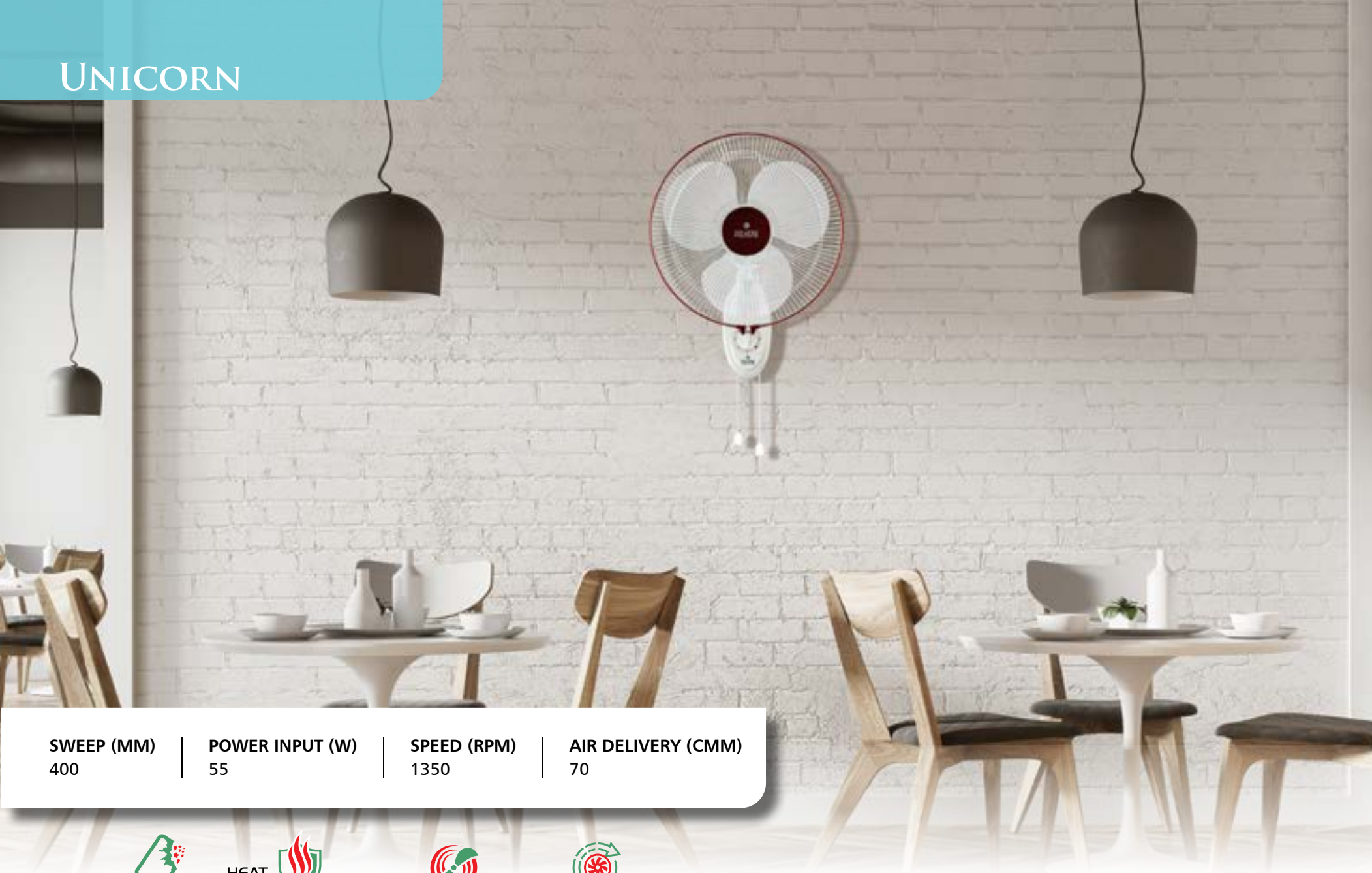

SWEEP (MM) 400	POWER INPUT (W) 55	SPEED (RPM) 1350	AIR DELIVERY (CMM) 70
--------------------------	------------------------------	----------------------------	---------------------------------

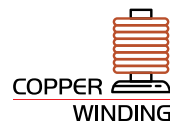

AERODYNAMIC BLADES
and cutting edge design

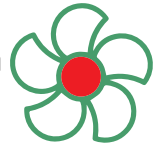

WHITE MAROON

Also available in:



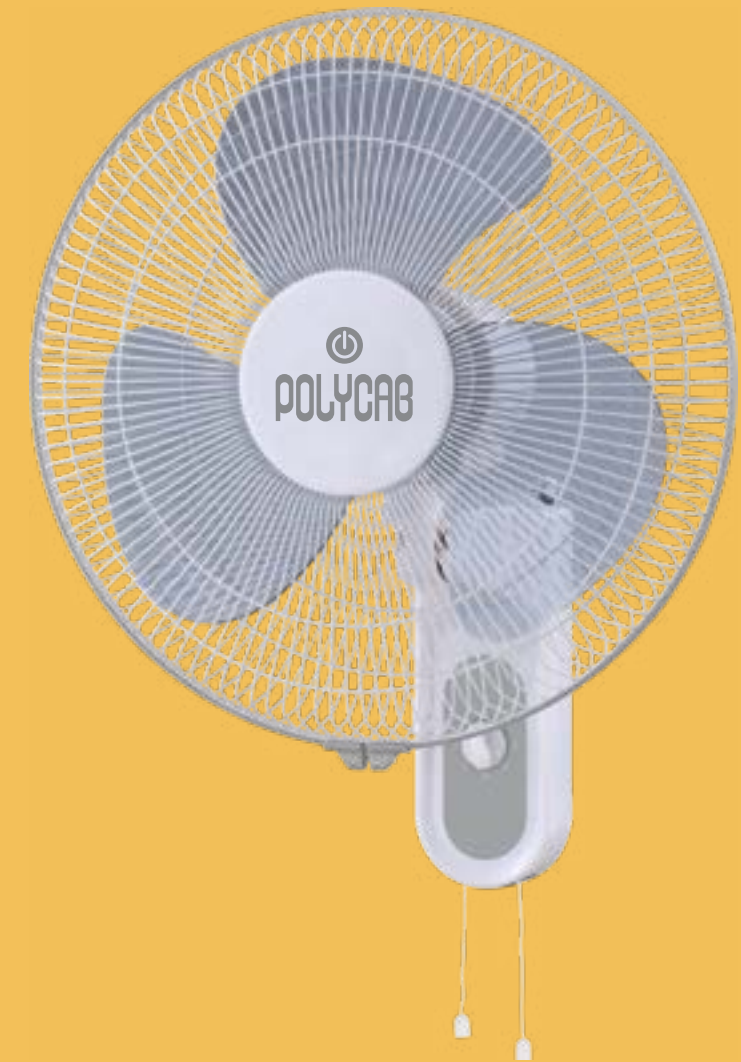

WHITE GREY

SWEEP (MM)	POWER INPUT (W)	SPEED (RPM)	AIR DELIVERY (CMM)
400	50	1350	65

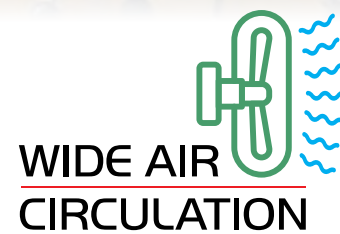
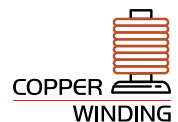



SWEEP (MM) 400	POWER INPUT (W) 70	SPEED (RPM) 1350	AIR DELIVERY (CMM) 85
--------------------------	------------------------------	----------------------------	---------------------------------

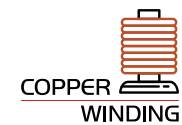

WIDE AIR CIRCULATION

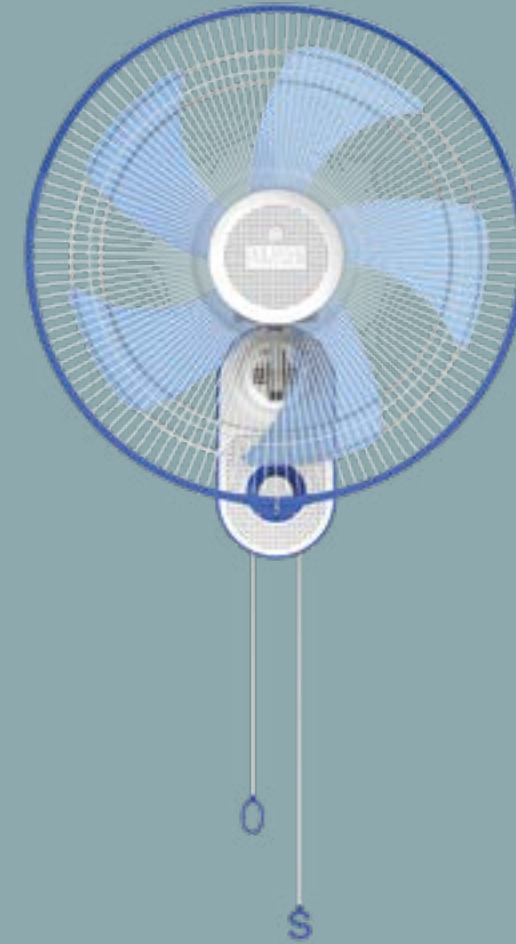

WHITE BLUE

AMAZE



BROWN



Green



Blue



SWEEP (MM)
400

POWER INPUT (W)
60

SPEED (RPM)
1320

AIR DELIVERY (CMM)
80

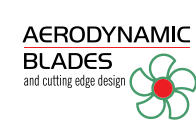
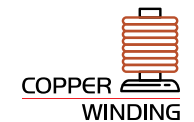

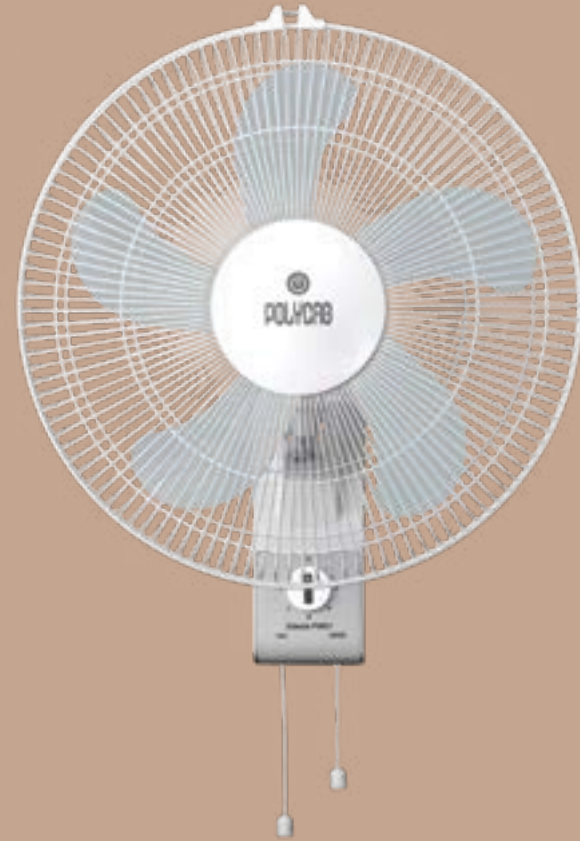

SWEEP (MM)	POWER INPUT (W)	SPEED (RPM)	AIR DELIVERY (CMM)
400	60	1330	70

- ANTI-RUST COATING** (Icon: Green shield with red rust spots)
- HEAT GUARD** Thermal Overload Protector (Icon: Red flame)
- HIGH AIR THRUST** (Icon: Red and green circular arrows)
- HEAVY DUTY MOTOR** (Icon: Green circular arrow)
- COPPER WINDING** (Icon: Copper wire coil)
- OPMP** Optimal Performance Minimal Power (Icon: Green star with red lightning bolt)
- WIDE AIR CIRCULATION** (Icon: Blue and green circular arrows)
- AERODYNAMIC BLADES** and cutting edge design (Icon: Green fan blades)

SMOOTH OSCILLATION

PERSONAL & CABIN FANS



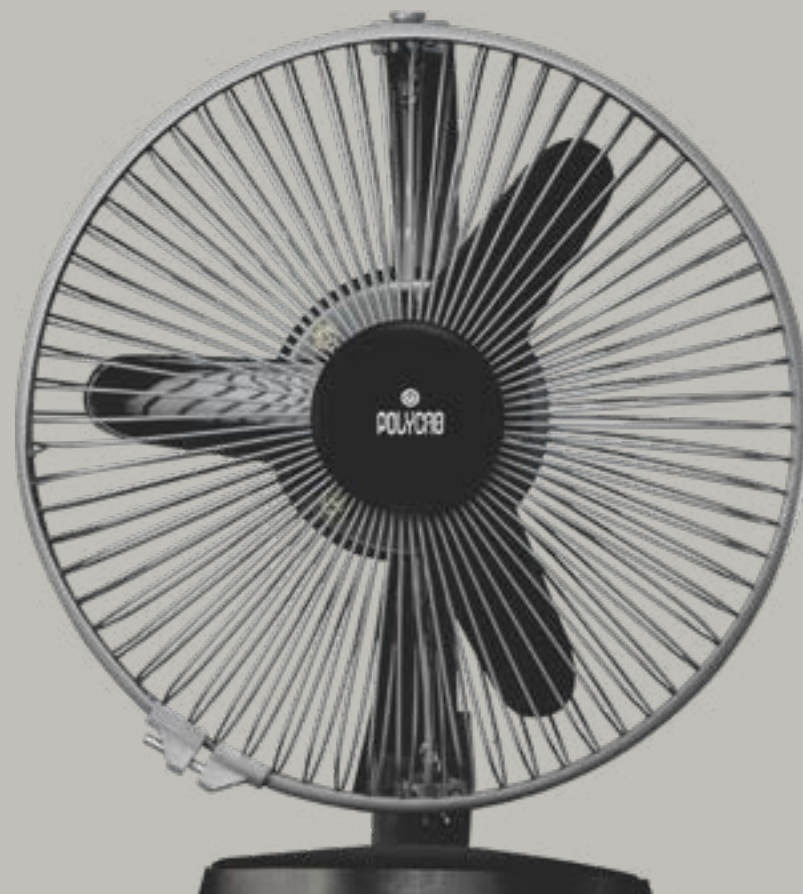

SWEEP (MM)	POWER INPUT (W)	SPEED (RPM)	AIR DELIVERY (CMH)
225	50	2600	1750

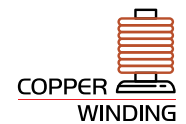

PEPPY PERSONAL FAN



SWEEP (MM) 175	POWER INPUT (W) 18	SPEED (RPM) 2300	AIR DELIVERY (CMH) 600
--------------------------	------------------------------	----------------------------	----------------------------------

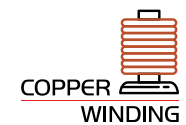

FANTASY CABIN FAN

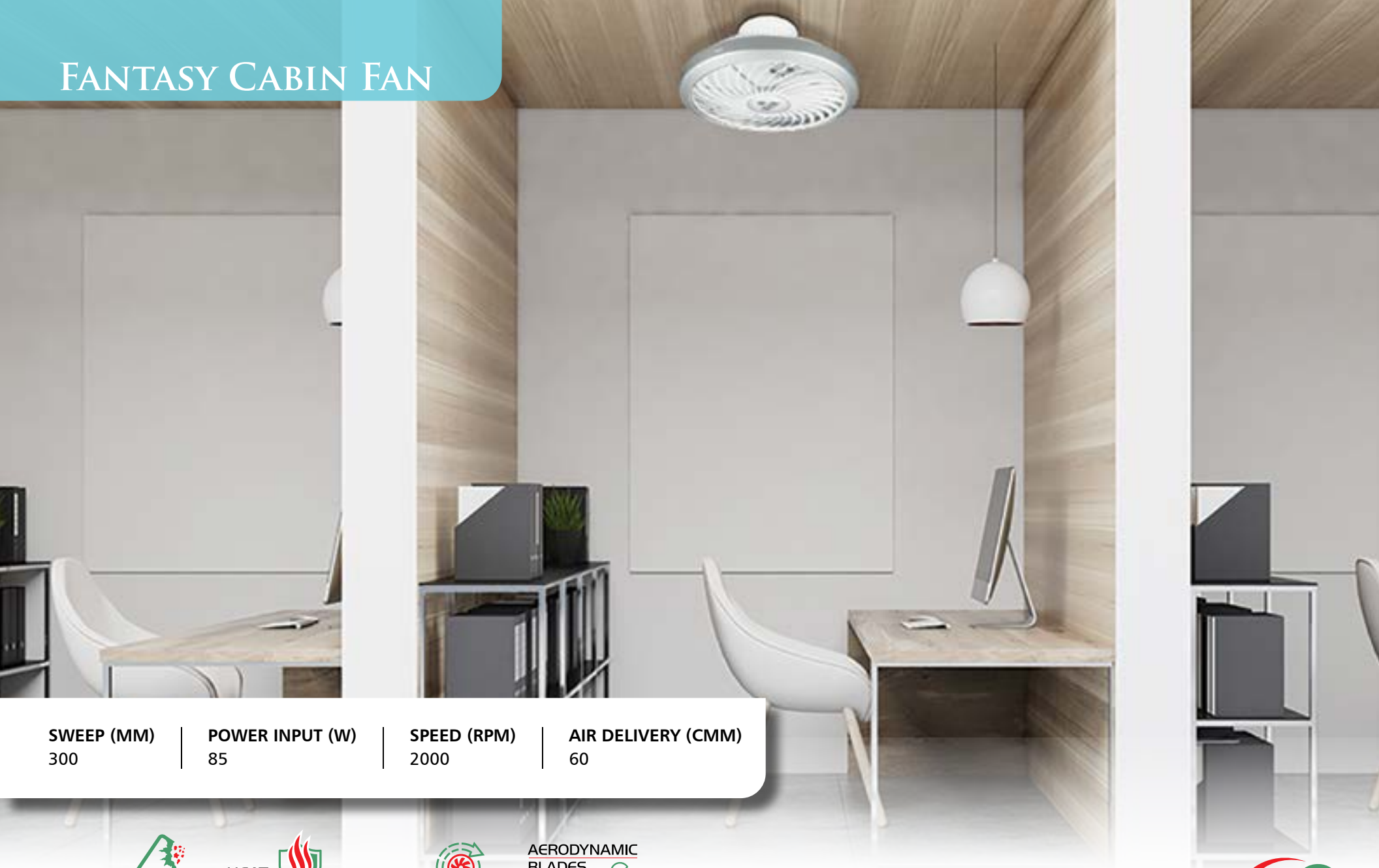

SWEEP (MM)	POWER INPUT (W)	SPEED (RPM)	AIR DELIVERY (CMM)
300	85	2000	60

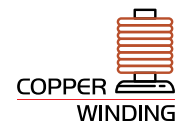

FARRATA FANS



MAARUT OSCILLATING



SWEEP (MM)	POWER INPUT (W)	SPEED (RPM)	AIR DELIVERY (CMM)
450	110	1400	90



ANTI-RUST COATING



HEAT GUARD
Thermal Overload Protector



HIGH AIR THRUST



HEAVY DUTY MOTOR



AERODYNAMIC BLADES
and cutting edge design



COPPER WINDING



OPMP
Optimal Performance Minimal Power



SMOOTH OSCILLATION



WIDE AIR CIRCULATION



CHILD SAFETY GUARD



90 DEGREE OSCILLATION



SUNAMI FARRATA



SWEEP (MM)	POWER INPUT (W)	SPEED (RPM)	AIR DELIVERY (CMM)
500	130	1360	120



SUNAMI MK III



SWEEP (MM)	POWER INPUT (W)	SPEED (RPM)	AIR DELIVERY (CMM)
450	130	2600	90

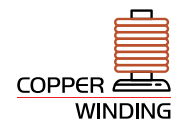

TOOFAN FARRATA

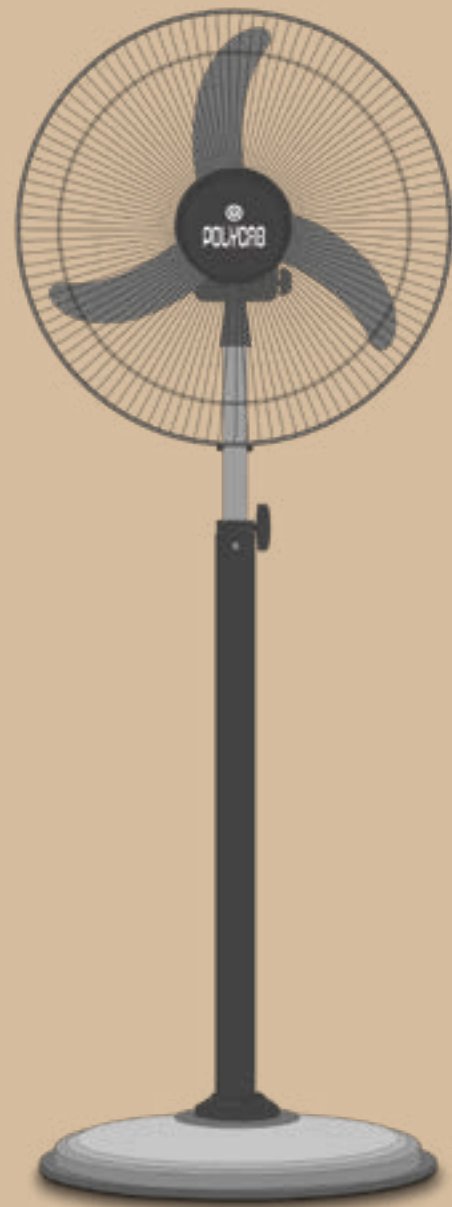

SWEEP (MM)	POWER INPUT (W)	SPEED (RPM)	AIR DELIVERY (CMM)
400	105	2100	120



PAWAN FARRATA



SWEEP (MM) 450	POWER INPUT (W) 145	SPEED (RPM) 1400	AIR DELIVERY (CMM) 140
--------------------------	-------------------------------	----------------------------	----------------------------------

ANTI-RUST COATING

HEAT GUARD
Thermal Overload Protector

HIGH AIR THRUST

HEAVY DUTY MOTOR

TEMPERATURE OVERLOAD PROTECTION

COPPER WINDING

OPMP
Optimal Performance Minimal Power

WIDE AIR CIRCULATION

ADJUSTABLE HEIGHT

DYNAMIC DESIGNED
with 4 Blades for higher air delivery

ANTI-CLOCK WISE

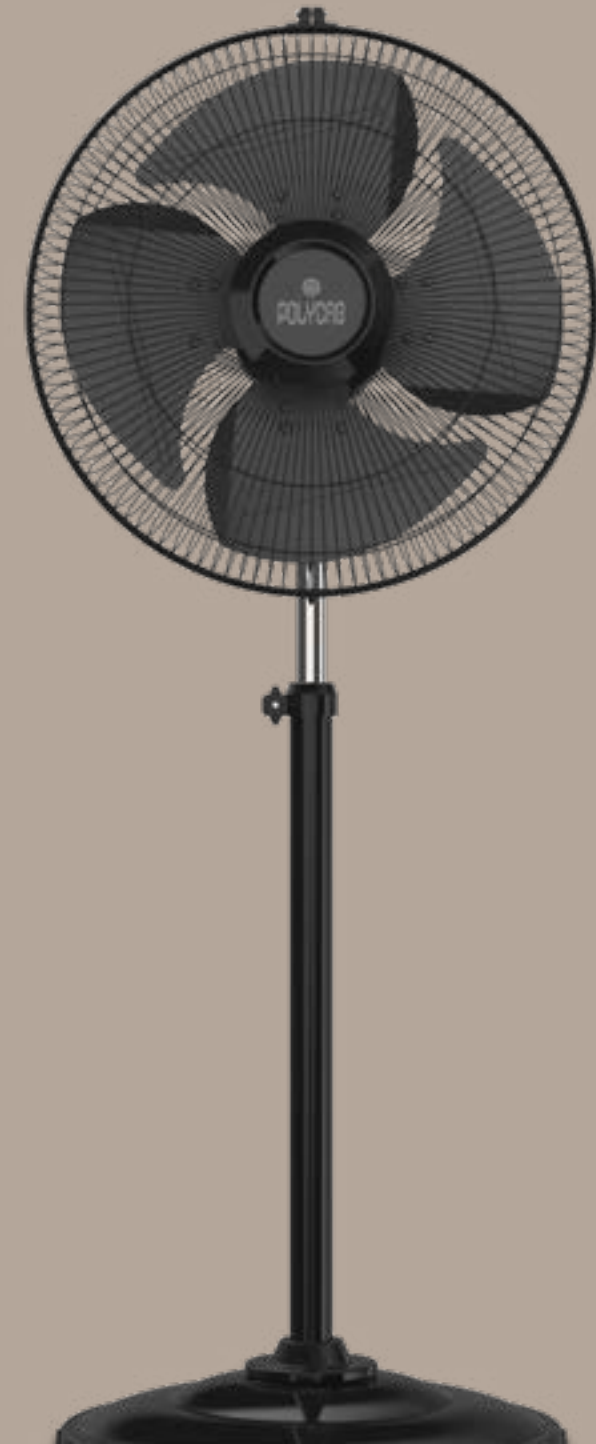

AIR CIRCULATOR FANS



AIR CIRCULATOR SUPERB WALL FAN



SWEEP (MM)	POWER INPUT (W)	SPEED (RPM)	AIR DELIVERY (CMM)
450 / 600 / 750	125 / 200 / 250	1400 / 1400 / 1400	150 / 250 / 370

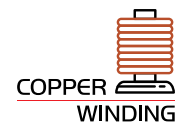

HIGH AIR THRUST



AIR CIRCULATOR SUPERB PEDESTAL FAN

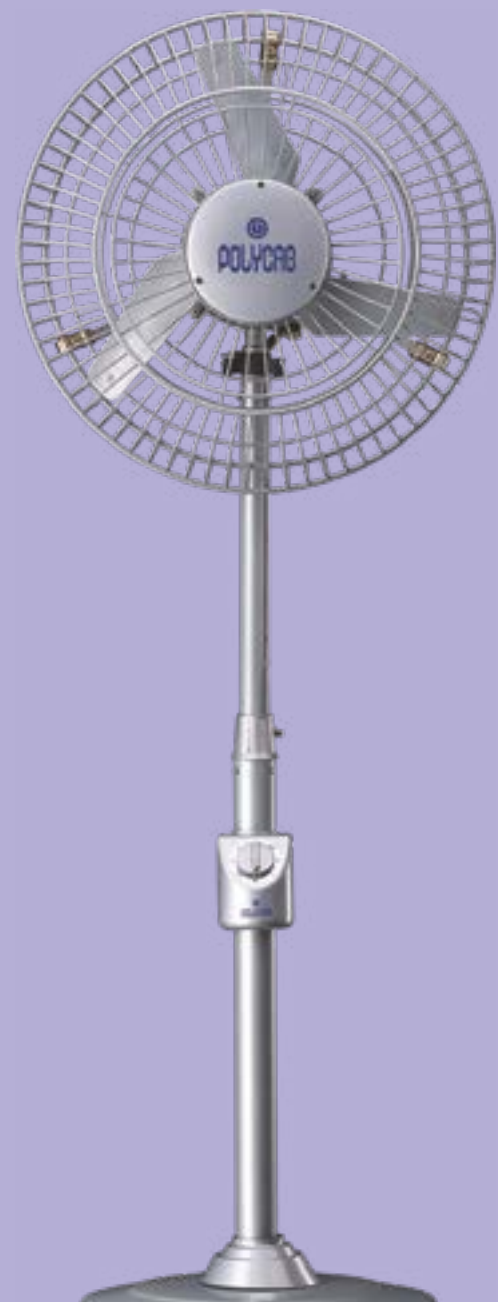

SWEEP (MM)	POWER INPUT (W)	SPEED (RPM)	AIR DELIVERY (CMM)
450 / 600 / 750	125 / 200 / 250	1400 / 1400 / 1400	150 / 250 / 370

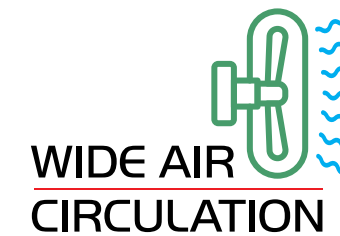
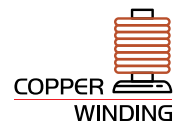

EXHAUST FANS



FRESHNER VENTILATION



Also available in:



BLACK

Also available in Normal Speed



NORMAL SPEED

SWEEP (MM)	POWER INPUT (W)	SPEED (RPM)	AIR DELIVERY (CMH)
150 / 200 / 250	35 / 38 / 40	1350 / 1300 / 1250	275 / 500 / 650

HIGH SPEED

SWEEP (MM)	POWER INPUT (W)	SPEED (RPM)	AIR DELIVERY (CMH)
150 / 200	60 / 65	2000 / 2000	350 / 700

FRESH AIR	EASY TO CLEAN	AERODYNAMIC BLADES and cutting edge design	SILENT OPERATION
HIGH AIR THRUST	HEAVY DUTY MOTOR	COPPER WINDING	HIGH SPEED
			POWERFUL EXHAUST

LOUVER OPENING

FRESHNER AXL



SWEEP (MM)	POWER INPUT (W)	SPEED (RPM)	AIR DELIVERY (CMH)
100 / 150	15 / 20	2000 / 2000	105 / 240



Also available in:





SWEEP (MM)	POWER INPUT (W)	SPEED (RPM)	AIR DELIVERY (CMH)
225 / 300	40 / 75	1400 / 1350	795 / 1884

-  FRESH AIR
-  EASY TO CLEAN
-  AERODYNAMIC BLADES and cutting edge design
-  SILENT OPERATION
-  POWERFUL EXHAUST
-  HIGH AIR THRUST
-  ANTI-RUST COATING
-  HEAVY DUTY MOTOR
-  COPPER WINDING
-  POWDER COATED

DOUBLE BALL BEARING

FRESHNER ES METAL



SWEEP (MM)	POWER INPUT (W)	SPEED (RPM)	AIR DELIVERY (CMH)
150 / 225 / 300	55 / 60 / 55	2500 / 2300 / 1400	600 / 700 / 1050

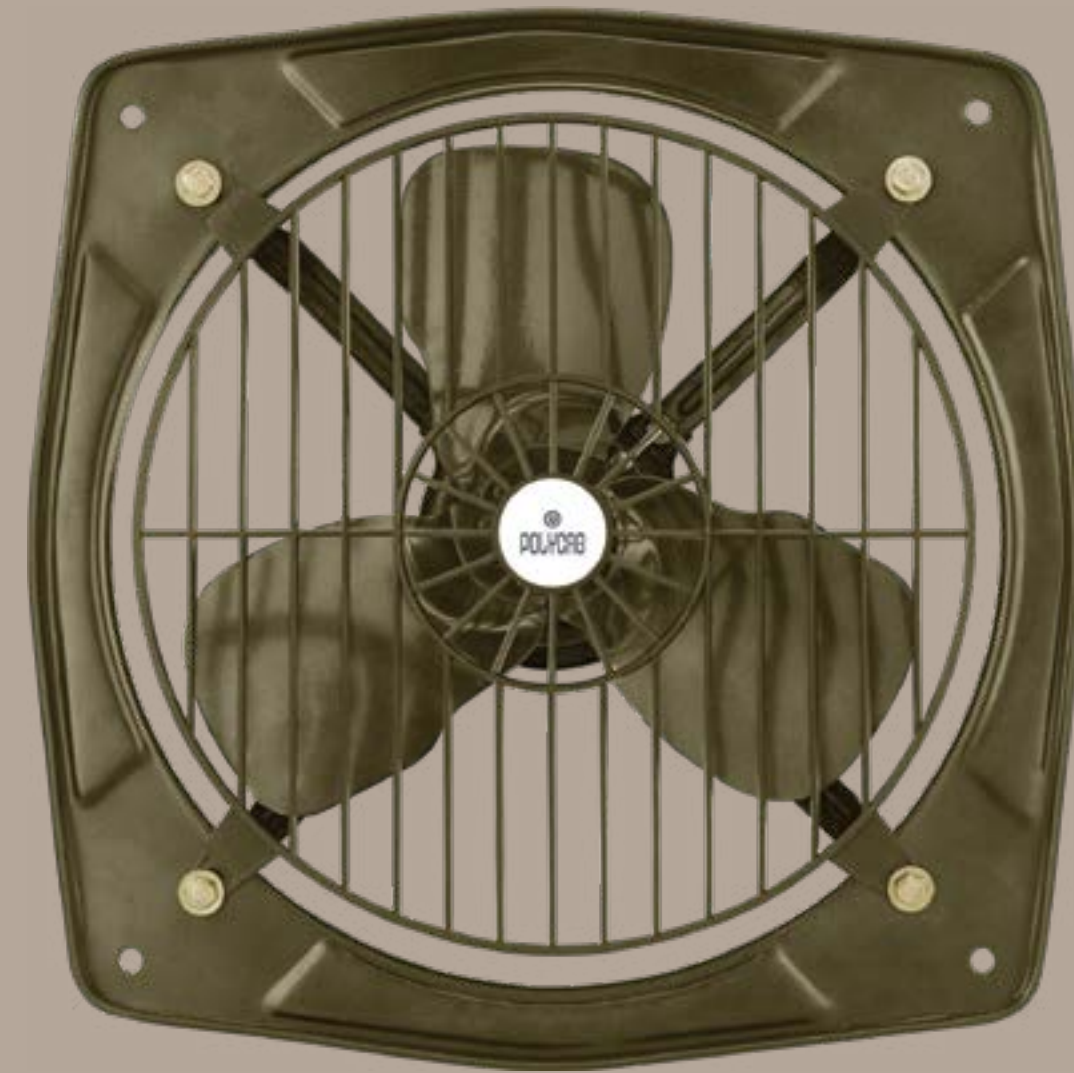
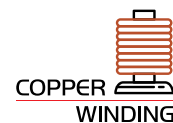

AIRO FRESH



SWEEP (MM)	POWER INPUT (W)	SPEED (RPM)	AIR DELIVERY (CMH)
100 / 150	15 / 22	2600 / 2400	125 / 275



FRESHOBREEZE



WHITE

SWEEP (MM)	POWER INPUT (W)	SPEED (RPM)	AIR DELIVERY (CMH)
150 / 200 / 250	22 / 30 / 33 / 37 / 47	1250 / 1350 / 1400 / 2250 / 2600	350 / 450 / 550 / 780 / 900



FRESH AIR



EASY TO CLEAN



AERODYNAMIC BLADES
and cutting edge design



POWERFUL EXHAUST



HIGH AIR THRUST



HEAVY DUTY MOTOR

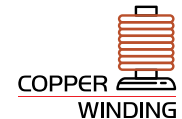

COPPER WINDING



HIGH SPEED



SILENT OPERATION



BLACK

Available in High Speed & Normal Speed
Only 150 and 200 MM are available in High Speed



SWEEP (MM)	POWER INPUT (W)	SPEED (RPM)	AIR DELIVERY (CMH)
150	22	2000	314



EASY TO CLEAN



AERODYNAMIC BLADES and cutting edge design



SILENT OPERATION



POWERFUL EXHAUST



HIGH AIR THRUST

208



HEAVY DUTY MOTOR



COPPER WINDING



HIGH SPEED



SUPERB HEAVY DUTY



SWEEP (MM)	POWER INPUT (W)	SPEED (RPM)	AIR DELIVERY (CMH)
300 / 380 / 450	220 / 220 / 220	1400 / 1400 / 1400	2000 / 4000 / 6000

FRESH AIR	EASY TO CLEAN	AERODYNAMIC BLADES and cutting edge design	SILENT OPERATION	POWERFUL EXHAUST
HIGH AIR THRUST	ANTI-RUST COATING	COPPER WINDING	EPOXY COATING	



WHOOSH



POLYCAB

SWEEP (MM)	POWER INPUT (W)	SPEED (RPM)	AIR DELIVERY (CMH)
225 / 300	40 / 50	1400 / 1400	800 / 1200

- FRESH AIR
- EASY TO CLEAN
- AERODYNAMIC BLADES and cutting edge design
- SILENT OPERATION
- POWERFUL EXHAUST
- ANTI-RUST COATING
- HEAVY DUTY MOTOR
- COPPER WINDING
- EPOXY COATING

ANTI-DUST BLADES



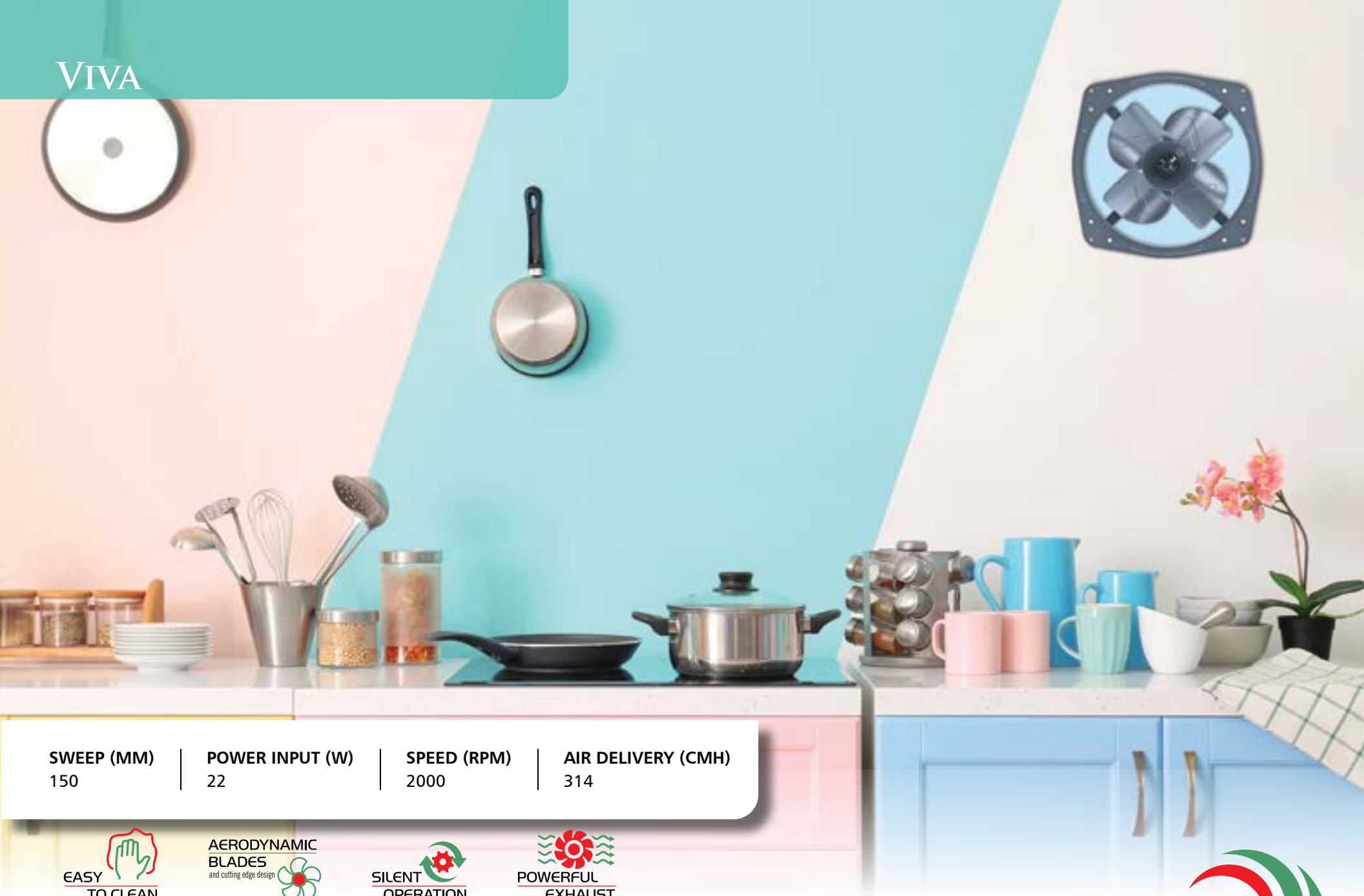

SWEEP (MM)	POWER INPUT (W)	SPEED (RPM)	AIR DELIVERY (CMH)
150	22	2000	314



EASY TO CLEAN



AERODYNAMIC BLADES and cutting edge design



SILENT OPERATION



POWERFUL EXHAUST



HIGH AIR THRUST



HEAVY DUTY MOTOR



COPPER WINDING



HIGH SPEED 2000 RPM



Regional & Branch Offices:

Kolkata : Unit No. 1108, 11th Floor Godrej Genesis Plot- XI, Block Ep & Gp Salt Lake, Sector – V, Kolkata- 700091

Bhubaneswar : A-167 ,Unit No.102 ,First Floor, The Metropolis, Near Sparsh Hospital,Saheed Nagar, Bhubaneswar–751007, Odisha, Tel.0674 2549960

Patna : L-302,303, Dumraon Palace, 3rd Floor, Fraser Road, Near Dakbangla Crossing, Patna – 800001

Ranchi : 2A, 2nd Floor, Poornima Tower, Opp-Chaganlal Jain Dharamshala, Lake Road, Ranchi: 834001 (Jharkhand)

Guwahati : 4th Floor, Mayur Garden Near ABC Bus Stop, G.S. Road Guwahati 781005, Assam, India

Noida : B 9, 1st Floor ,Sector -3 Noida -201301 Tel.0120 4848550

Mohali : Unit No.B-424,Bestech Business Towers, Sector 66, Mohali, Punjab – 160055

Kochi : Door No. XXV/578 C , Pathicheril Enclave Nh – 47 , Metro Pillar – 329 South Kalamassery Ernakulam , Kochi – 682033 Kerala PH: 0484 – 3500397

Bangalore : 2nd Floor, B-78, No.18, 4th Main Road, Kssidc Industrial Estate, 6th Block, Rajajinagar, Bangalore – 560010 Ph :080 - 23156747 / 23156748

Hyderabad : 208-209, 2nd Floor ,Bhuvana Towers S.D. Road, Hyderabad - 500 003

Chennai : Gee Gee Universal 8th Floor, No.2, Mc Nichols Road, 3rd Lane Near Metha Hospital Chetpet, Chennai – 600 031 Phone. 044-42817272

Ahmedabad : 102-1st Floor, Hrishikesh, Opp. Gulbai Tekra water tank, Nr. IDBI Bank Cross Road, Ahmedabad-380006 Tel. 079 26301655

Pune : Off No. 36, Sangam Project Phase 2, Near RTO Pune, Near Sangam Bridge, Pune – 411001, Tel. 020 26058277

Mumbai : Polycab House ,771 PS Marg, Mahim (W) Mumbai - 400016 Tel. 022 24327070

Our friendly Customer Care Team is available to help you 24 hours a day, seven days a week.

Email: customercare@polycab.com | Toll Free No.: 18002670008

Working Days: Monday to Saturday | Timings: 9:00 AM to 6:00 PM

Terms & Conditions:

Pictures and details of the product(s) in this catalogue are merely illustrative. Actual products may vary in colour, design, description and colour combination etc. Due care has been taken that the information provided herein is accurate but is subject to human error. The information is updated from time to time. Polycab India Limited reserves its rights to amend data/details without prior notice.

Corporate Office:

POLYCAB INDIA LIMITED

Polycab House, 771, Mogul Lane, Mahim (W), Mumbai - 400 016,

Maharashtra (India) Ph.: +91-22-2432 7070/4, 6735 1400,

Toll Free No.: 1800 267 0008.

Email: enquiry@polycab.com

Web Site: www.Polycab.com

Follow us on:  [@PolycabInd](https://www.facebook.com/PolycabInd)  [@polycabindia](https://www.instagram.com/polycabindia)  [@PolycabIndia](https://twitter.com/PolycabIndia)  [@polycabindia](https://www.linkedin.com/company/polycabindia)  [@PolycabInd](https://www.youtube.com/PolycabInd)
(Click to view)

Shop Online : 